

LECTURE NOTES
ON
ELECTRICAL MACHINES-I

II B. Tech I semester (JNTU)

KITS GUNTUR

Prepared By
Dr. M. AMARENDRA

COURSE STRUCTURE AND SYLLABUS

For

ELECTRICAL AND ELECTRONICS ENGINEERING

(Applicable for batches admitted from 2016-2017)



JAWAHARLAL NEHRU TECHNOLOGICAL UNIVERSITY: KAKINADA
KAKINADA - 533 003, Andhra Pradesh, India

II Year – I SEMESTER

L	T	P	C
4	0	0	3

ELECTRICAL MACHINES – I

Preamble:

This is a basic course on rotating electrical machines. This course covers the topics related to principles, performance, applications and design considerations of dc machines and transformers.

Learning objectives:

- Understand the unifying principles of electromagnetic energy conversion.
- Understand the construction, principle of operation and performance of DC machines.
- Learn the characteristics, performance, methods of speed control and testing methods of DC motors.
- To predetermine the performance of single phase transformers with equivalent circuit models.
- Understand the methods of testing of single-phase transformer.
- Analyze the three phase transformers and achieve three phase to two phase conversion.

UNIT-I:

Electromechanical Energy Conversion and introduction to DC machines

Principles of electromechanical energy conversion – singly excited and multi excited system – Calculation of force and torque using the concept of co-energy.

Construction and principle of operation of DC machine – EMF equation for generator – Classification of DC machines based on excitation – OCC of DC shunt generator.

UNIT-II:

Performance of D.C. Machines

Torque and back-emf equations of dc motors– Armature reaction and commutation – characteristics of separately-excited, shunt, series and compound motors - losses and efficiency- applications of dc motors.

UNIT-III:

Starting, Speed Control and Testing of D.C. Machines

Necessity of starter – Starting by 3 point and 4 point starters – Speed control by armature voltage and field control – testing of DC machines - brake test, Swinburne's method – principle of regenerative or Hopkinson's method - retardation test -- separation of losses.

UNIT-IV:

Single-phase Transformers

Types and constructional details - principle of operation - emf equation - operation on no load and on load – lagging, leading and unity power factors loads - phasor diagrams of transformers – equivalent circuit – regulation – losses and efficiency – effect of variation of frequency and supply voltage on losses – All day efficiency.

UNIT-V

Single-phase Transformers Testing

Tests on single phase transformers – open circuit and short circuit tests – Sumpner's test – separation of losses – parallel operation with equal voltage ratios – auto transformer - equivalent circuit – comparison with two winding transformers.

UNIT-VI

3-Phase Transformers

Polyphase connections - Y/Y, Y/ Δ , Δ /Y, Δ / Δ and open Δ -- Third harmonics in phase voltages - three winding transformers: determination of Z_p , Z_s and Z_t -- transients in switching - off load and on load tap changers -- Scott connection.

Learning outcomes:

- Able to assimilate the concepts of electromechanical energy conversion.
- Able to mitigate the ill-effects of armature reaction and improve commutation in dc machines.
- Able to understand the torque production mechanism and control the speed of dc motors.
- Able to analyze the performance of single phase transformers.
- Able to predetermine regulation, losses and efficiency of single phase transformers.
- Able to parallel transformers, control voltages with tap changing methods and achieve three-phase to two-phase transformation.

Text Books:

1. Electrical Machines – P.S. Bhimbra, Khanna Publishers
2. Electric Machinery by A.E.Fitzgerald, Charles Kingsley, Stephen D. Umans, TMH

Reference Books:

1. Electrical Machines by D. P. Kothari, I. J. Nagarth, McGraw Hill Publications, 4th edition
2. Electrical Machines by R.K. Rajput, Lakshmi publications, 5th edition.
3. Electrical Machinery by Abijith Chakrabarti and Sudhita Debnath, McGraw Hill education 2015
4. Electrical Machinery Fundamentals by Stephen J Chapman McGraw Hill education 2010
5. Electric Machines by Mulukutla S. Sarma & Mukesh K. Pathak, CENGAGE Learning.
6. Theory & Performance of Electrical Machines by J.B. Gupta. S.K. Kataria & Sons

KKR & KSR INSTITUTE OF TECHNOLOGY & SCIENCES

Department of Electrical and Electronics Engineering

COURSE OUTCOMES

Faculty Name: Dr. M. Amarendra Year/SEM: II B.Tech I SEM Academic year: 2017-18

Subject: **Electrical Machines-1**

CO212.1	Assimilate the concepts of electromechanical energy conversion.	Comprehension TL 2
CO212.2	Analyze and mitigate the ill-effects of armature reaction and improve commutation in dc machines.	Analyze TL4
CO212.3	Formulate the torque production, working mechanism, finding the performance and control the speed of dc motors.	Application TL3
CO212.4	Analyze the performance of single phase transformers.	Analyze TL4
CO212.5	Predetermine regulation, losses and efficiency of single phase transformers.	Application TL3
CO212.6	Develop parallel transformers, control voltages with tap changing methods and achieve Three-phase to two-phase transformation.	Application TL3

Signature of Course Coordinator

Signature of HOD

Principles of Electromechanical Energy Conversion

Topics to cover:

- | | |
|--|---|
| 1) <i>Introduction</i> | 4) <i>Force and Torque Calculation from Energy and Coenergy</i> |
| 2) <i>EMF in Electromechanical Systems</i> | 5) <i>Model of Electromechanical Systems</i> |
| 3) <i>Force and Torque on a Conductor</i> | |

Introduction

For energy conversion between electrical and mechanical forms, electromechanical devices are developed. In general, electromechanical energy conversion devices can be divided into three categories:

- (1) Transducers (for measurement and control)

These devices transform the signals of different forms. Examples are microphones, pickups, and speakers.

- (2) Force producing devices (linear motion devices)

These type of devices produce forces mostly for linear motion drives, such as relays, solenoids (linear actuators), and electromagnets.

- (3) Continuous energy conversion equipment

These devices operate in rotating mode. A device would be known as a generator if it convert mechanical energy into electrical energy, or as a motor if it does the other way around (from electrical to mechanical).

Since the permeability of ferromagnetic materials are much larger than the permittivity of dielectric materials, it is more advantageous to use electromagnetic field as the medium for electromechanical energy conversion. As illustrated in the following diagram, an electromechanical system consists of an electrical subsystem (electric circuits such as windings), a magnetic subsystem (magnetic field in the magnetic cores and airgaps), and a mechanical subsystem (mechanically movable parts such as a plunger in a linear actuator and a rotor in a rotating electrical machine). Voltages and currents are used to describe the

state of the electrical subsystem and they are governed by the basic circuit laws: Ohm's law, KCL and KVL. The state of the mechanical subsystem can be described in terms of positions, velocities, and accelerations, and is governed by the Newton's laws. The magnetic subsystem or magnetic field fits between the electrical and mechanical subsystems and acting as a "ferry" in energy transform and conversion. The field quantities such as magnetic flux, flux density, and field strength, are governed by the Maxwell's equations. When coupled with an electric circuit, the magnetic flux interacting with the current in the circuit would produce a force or torque on a mechanically movable part. On the other hand, the movement of the moving part will cause variation of the magnetic flux linking the electric circuit and induce an electromotive force (*emf*) in the circuit. The product of the torque and speed (the mechanical power) equals the active component of the product of the *emf* and current. Therefore, the electrical energy and the mechanical energy are inter-converted via the magnetic field.

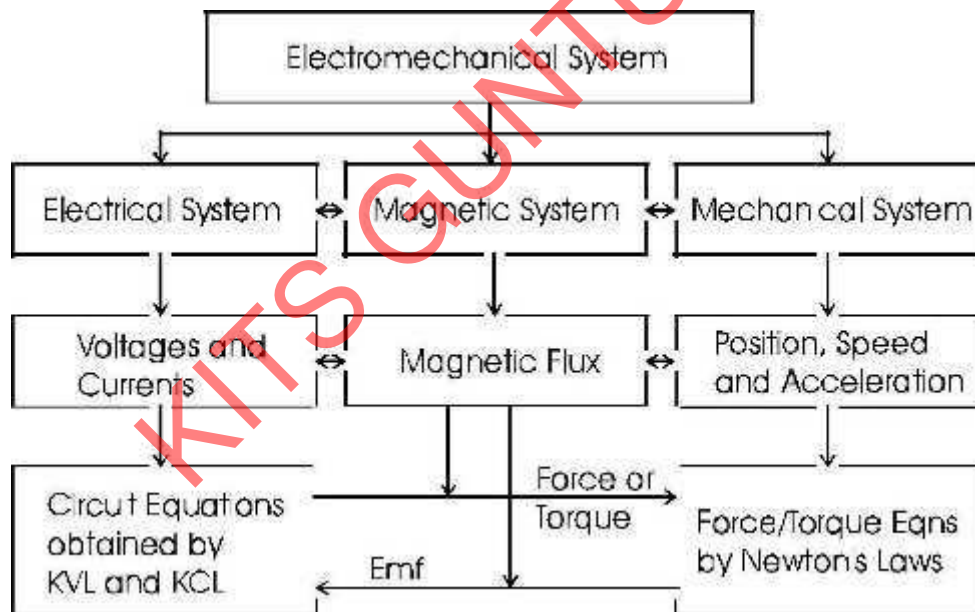

Concept map of electromechanical system modeling

In this chapter, the methods for determining the induced *emf* in an electrical circuit and force/torque experienced by a movable part will be discussed. The general concept of electromechanical system modeling will also be illustrated by a singly excited rotating system.

Induced *emf* in Electromechanical Systems

The diagram below shows a conductor of length l placed in a uniform magnetic field of flux density \mathbf{B} . When the conductor moves at a speed \mathbf{v} , the induced *emf* in the conductor can be determined by

$$\mathbf{e} = l\mathbf{v} \times \mathbf{B}$$

The direction of the *emf* can be determined by the "right hand rule" for cross products. In a coil of N turns, the induced *emf* can be calculated by

$$e = - \frac{d\lambda}{dt}$$

where λ is the flux linkage of the coil and the minus sign indicates that the induced current opposes the variation of the field. It makes no difference whether the variation of the flux linkage is a result of the field variation or coil movement.

In practice, it would be convenient if we treat the *emf* as a voltage. The above expression can then be rewritten as

$$e = d\lambda = L \frac{di}{dt} + i \frac{dL}{dx} dx$$

if the system is magnetically linear, i.e. the self inductance is independent of the current. It should be noted that the self *inductance is a function of the displacement* x since there is a moving part in the system.

Example:

Calculate the open circuit voltage between the brushes on a Faraday's disc as shown schematically in the diagram below.

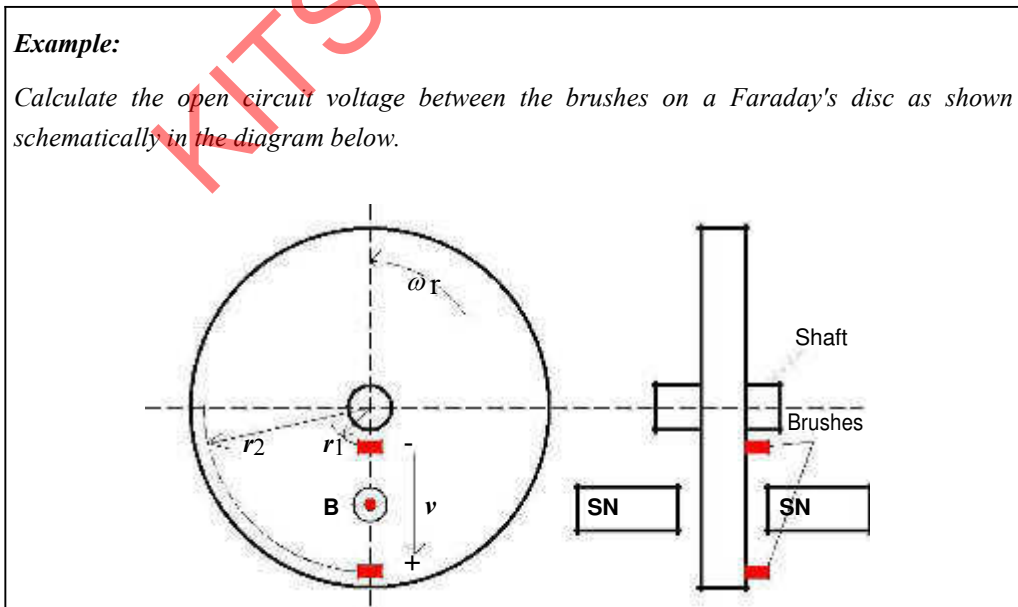

Solution:

Choose a small line segment of length dr at position r ($r_1 \leq r \leq r_2$) from the center of the disc between the brushes. The induced emf in this elemental length is then

$$de = Bvdr = B\omega r dr$$

where $v=r\omega$. Therefore,

$$\int_{r_1}^{r_2} \frac{r^2}{2} \Big|_{r_1}^{r_2} = \omega r B \frac{r^2 - r_1^2}{2}$$

Example:

Sketch $L(x)$ and calculate the induced emf in the excitation coil for a linear actuator shown below.

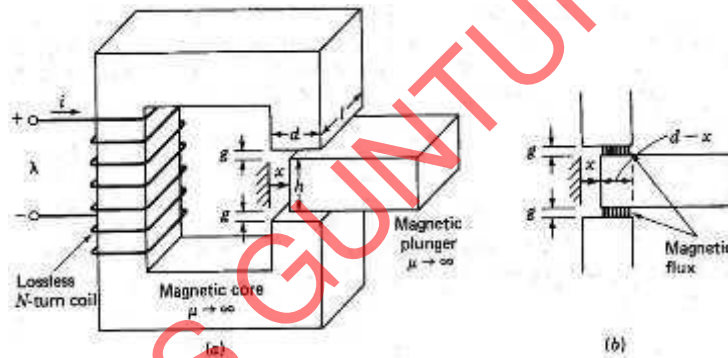

A singly excited linear actuator

Solution:

$$L(x) = \frac{N^2}{R_g(x)}$$

and

$$R_g(x) = \frac{2g}{\mu_0(d-x)l}$$

$$\underline{\underline{\mu N^2 l (d-x)}}$$

$$e = \frac{d\lambda}{dt} = L \frac{di}{dt} + i \frac{dL}{dx} \frac{dx}{dt}$$

$$= L(x) \frac{di}{dt} - i \frac{\mu N^2 l}{2g} v$$

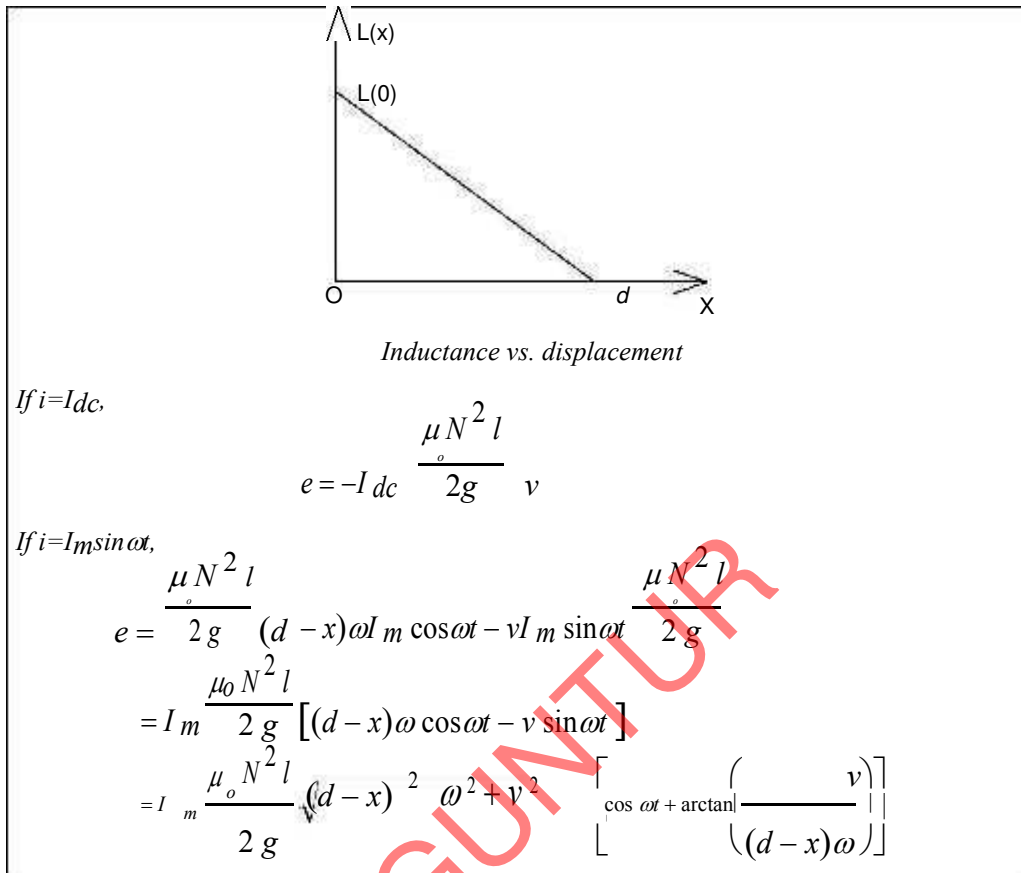

Force and Torque on a Current Carrying Conductor

The force on a moving particle of electric charge q in a magnetic field is given by the Lorentz's force law:

$$\mathbf{F} = q(\mathbf{v} \times \mathbf{B})$$

The force acting on a current carrying conductor can be directly derived from the equation as

$$\mathbf{F} = I \int_C d\mathbf{l} \times \mathbf{B}$$

where C is the contour of the conductor. For a homogeneous conductor of length l carrying current I in a uniform magnetic field, the above expression can be reduced to

$$\mathbf{F} = I(\mathbf{l} \times \mathbf{B})$$

In a rotating system, the torque about an axis can be calculated by

$$\mathbf{T} = \mathbf{r} \times \mathbf{F}$$

where \mathbf{r} is the radius vector from the axis towards the conductor.

Example:

Calculate the torque produced by the Faraday's disc if a dc current I_{dc} flows from the positive terminal to the negative terminal as shown below.

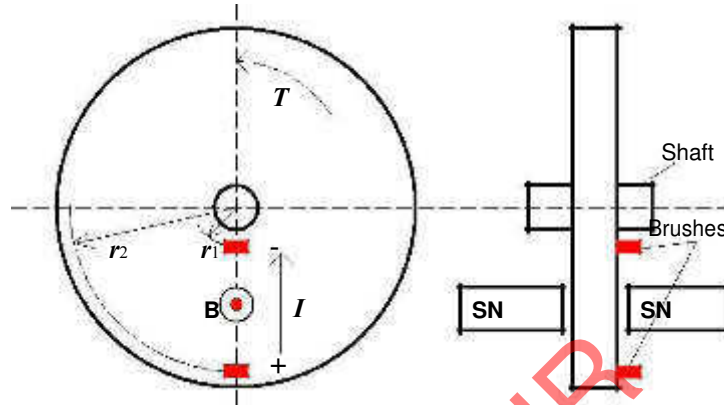

Solution:

Choose a small segment of length dr at position r ($r_1 \leq r \leq r_2$) between the brushes. The force generated by this segment is

$$d\mathbf{F} = (-I dr \mathbf{r} \times \mathbf{B}) \times \mathbf{a}_z = IB dr \mathbf{a}_\theta$$

where \mathbf{a}_θ is the unit vector in θ direction. The corresponding torque is

$$d\mathbf{T} = \mathbf{r} \times d\mathbf{F} = IB r dr \mathbf{a}_z$$

Therefore,

$$T = \int_{r_1}^{r_2} dT = \int_{r_1}^{r_2} IB r dr \mathbf{a}_z = IB \frac{r^2 - r_1^2}{2} \mathbf{a}_z$$

Force and Torque Calculation from Energy and Coenergy

A Singly Excited Linear Actuator

Consider a singly excited linear actuator as shown below. The winding resistance is R . At a certain time instant t , we record that the terminal voltage applied to the excitation winding is v , the excitation winding current i , the position of the movable plunger x , and the force acting on the plunger \mathbf{F} with the reference direction chosen in the positive direction of the x axis, as shown in the diagram. After a time interval dt , we notice that the plunger has

moved for a distance dx under the action of the force

F . The mechanical done by the force acting on the plunger during this time interval is thus

$$dW_m = Fdx$$

The amount of electrical energy that has been transferred into the magnetic field and converted into the mechanical work during this time interval can be calculated by subtracting the power loss dissipated in the

winding resistance from the total power fed into the excitation winding as

$$dW_e = dW_f + dW_m = vidt - Ri^2 dt$$

Because

$$e = \frac{d\lambda}{dt} = v - Ri$$

we can write

$$dW_f = dW_e - dW_m = eidt - Fdx$$

$$= id\lambda - Fdx$$

From the above equation, we know that the energy stored in the magnetic field is a function of the flux linkage of the excitation winding and the position of the plunger. Mathematically, we can also write

$$dW_f(\lambda, x) = \frac{\partial W_f(\lambda, x)}{\partial \lambda} d\lambda + \frac{\partial W_f(\lambda, x)}{\partial x} dx$$

Therefore, by comparing the above two equations, we conclude

$$i = \frac{\partial W_f(\lambda, x)}{\partial \lambda} \quad \text{and} \quad F = - \frac{\partial W_f(\lambda, x)}{\partial x}$$

From the knowledge of electromagnetics, the energy stored in a magnetic field can be expressed as

$$W_f(\lambda, x) = \int_0^\lambda i(\lambda, x) d\lambda$$

For a magnetically linear (with a constant permeability or a straight line magnetization curve such that the inductance of the coil is independent of the excitation current) system, the above expression becomes

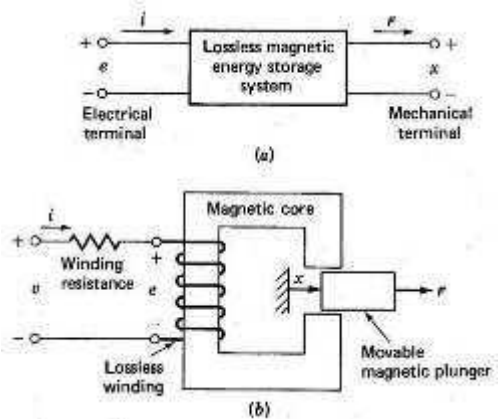

A singly excited linear actuator

$$W_f(\lambda, x) = \frac{1}{2} \frac{\lambda^2}{L(x)}$$

and the force acting on the plunger is then

$$F = - \frac{\partial W_f(\lambda, x)}{\partial x} = - \frac{1}{2} \frac{d}{dx} \left[\frac{\lambda^2}{L(x)} \right] = - \frac{1}{2} \frac{dL(x)}{dx}$$

In the diagram below, it is shown that the magnetic energy is equivalent to the area above the magnetization or λ - i curve. Mathematically, if we define the area underneath the magnetization curve as the **coenergy** (which does not exist physically), i.e.

$$W_f'(i, x) = i\lambda - W_f(\lambda, x)$$

we can obtain

$$\begin{aligned} dW_f'(i, x) &= \lambda di + i d\lambda - dW_f(\lambda, x) \\ &= \lambda di + F dx \\ &= \frac{\partial W_f'(i, x)}{\partial i} di + \frac{\partial W_f'(i, x)}{\partial x} dx \end{aligned}$$

Therefore,

$$\lambda = \frac{\partial W_f'(i, x)}{\partial i}$$

and $F = \frac{\partial W_f'(i, x)}{\partial x}$

From the above diagram, the coenergy or the area underneath the magnetization curve can be calculated by

$$W_f'(i, x) = \int_0^i \lambda(i, x) di$$

For a magnetically linear system, the above expression becomes

$$W_f'(i, x) = \frac{1}{2} i^2 L(x)$$

and the force acting on the plunger is then

$$F = \frac{\partial W_f'(i, x)}{\partial x} = \frac{1}{2} i^2 \frac{dL(x)}{dx}$$

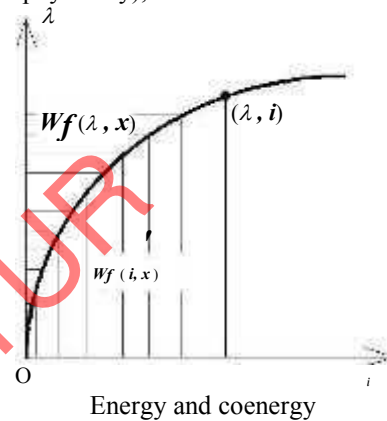

Example:

Calculate the force acting on the plunger of a linear actuator discussed in this section.

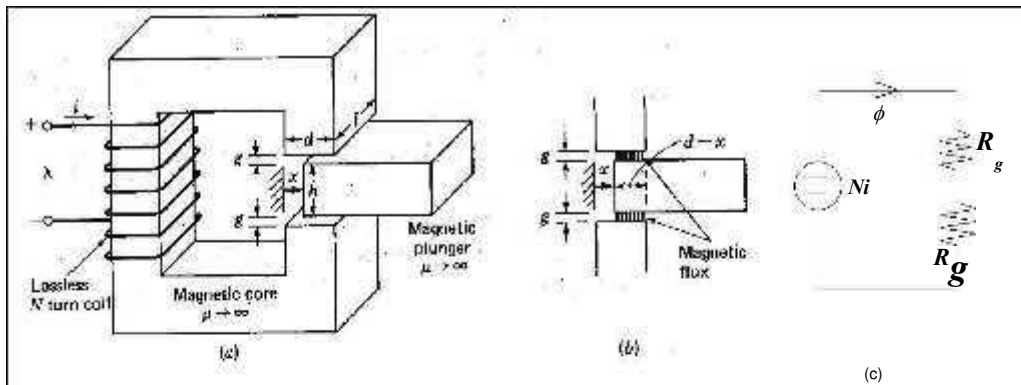

A singly excited linear actuator

Solution:

Assume the permeability of the magnetic core of the actuator is infinite, and hence the system can be treated as magnetically linear. From the equivalent magnetic circuit of the actuator shown in figure (c) above, one can readily find the self inductance of the excitation winding as

$$L(x) = \frac{N^2}{2 R_g} = \frac{\mu_0 N^2 l(d-x)}{2g}$$

Therefore, the force acting on the plunger is

$$F = \frac{1}{2} i^2 \frac{dL(x)}{dx} = -\frac{\mu_0 l}{4g} (Ni)^2$$

The minus sign of the force indicates that the direction of the force is to reduce the displacement so as to reduce the reluctance of the air gaps. Since this force is caused by the variation of magnetic reluctance of the magnetic circuit, it is known as the **reluctance force**.

Singly Excited Rotating Actuator

The singly excited linear actuator mentioned above becomes a singly excited rotating actuator if the linearly movable plunger is replaced by a rotor, as illustrated in the diagram below. Through a derivation similar to that for a singly excited linear actuator, one can readily obtain that the torque acting on the rotor can be expressed as the negative partial derivative of the energy stored in the magnetic field against the angular displacement or as the positive partial derivative of the coenergy against the angular displacement, as summarized in the following table.

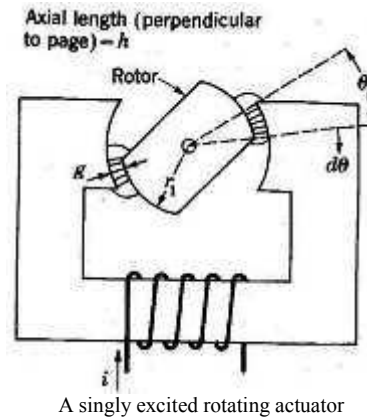

Table: Torque in a singly excited rotating actuator

Energy	Coenergy
<i>In general,</i>	
$dW_f = i d\lambda - T d\theta$	$dW_f' = \lambda di + T d\theta$
$w_f(\lambda, \theta) = \int_0^\lambda i(\lambda, \theta) d\lambda$	$w_f'(i, \theta) = \int_0^i \lambda(i, \theta) di$
$i = \frac{\partial W_f(\lambda, \theta)}{\partial \lambda}$	$\lambda = \frac{\partial W_f'(i, \theta)}{\partial i}$
$T = - \frac{\partial W_f(\lambda, \theta)}{\partial \theta}$	$T = \frac{\partial W_f'(i, \theta)}{\partial \theta}$
<i>If the permeability is a constant,</i>	
$w(\lambda, \theta) = \frac{1}{2} \lambda^2 L(\theta)$	$w_f'(i, \theta) = \frac{1}{2} i^2 L(\theta)$
$T = - \frac{1}{2} \frac{dL(\theta)}{d\theta}$	$T = \frac{1}{2} i^2 \frac{dL(\theta)}{d\theta}$

Doubly Excited Rotating Actuator

The general principle for force and torque calculation discussed above is equally applicable to multi-excited systems. Consider a doubly excited rotating actuator shown schematically in the diagram below as an example. The differential energy and coenergy functions can be derived as following:

$$dW_f = dW_e - dW_m$$

where $dW_e = e_1 i_1 dt + e_2 i_2 dt$

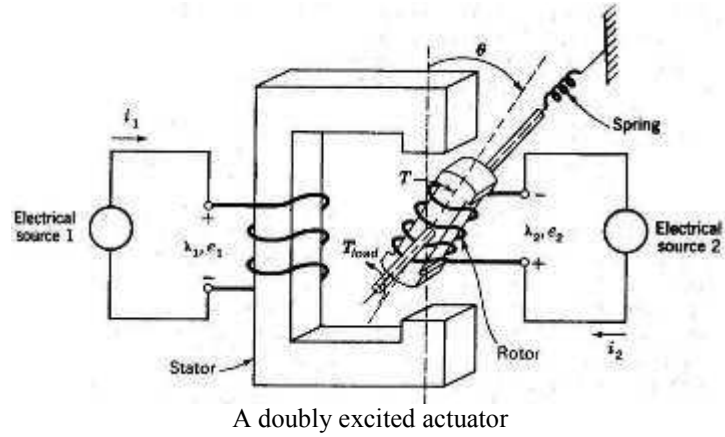

$$e_1 = \frac{d\lambda_1}{dt}, \quad e_2 = \frac{d\lambda_2}{dt}$$

and

$$dW_m = Td\theta$$

Hence,

$$\begin{aligned} dW_f(\lambda_1, \lambda_2, \theta) &= i_1 d\lambda_1 + i_2 d\lambda_2 - Td\theta \\ &= \frac{\partial W_f(\lambda_1, \lambda_2, \theta)}{\partial \lambda_1} d\lambda_1 + \frac{\partial W_f(\lambda_1, \lambda_2, \theta)}{\partial \lambda_2} d\lambda_2 \\ &\quad + \frac{\partial W_f(\lambda_1, \lambda_2, \theta)}{\partial \theta} d\theta \end{aligned}$$

and

$$\begin{aligned} dW_f'(i_1, i_2, \theta) &= d[i_1 \lambda_1 + i_2 \lambda_2 - W_f(\lambda_1, \lambda_2, \theta)] \\ &= \lambda_1 di_1 + \lambda_2 di_2 + Td\theta \\ &= \frac{\partial W_f'(i_1, i_2, \theta)}{\partial i_1} di_1 + \frac{\partial W_f'(i_1, i_2, \theta)}{\partial i_2} di_2 \\ &\quad + \frac{\partial W_f'(i_1, i_2, \theta)}{\partial \theta} d\theta \end{aligned}$$

Therefore, comparing the corresponding differential terms, we obtain

$$T = - \frac{\partial W_f(\lambda_1, \lambda_2, \theta)}{\partial \theta}$$

or

$$T = \frac{\partial W_f'(i_1, i_2, \theta)}{\partial \theta}$$

For magnetically linear systems, currents and flux linkages can be related by constant inductances as following

$$\begin{bmatrix} \lambda_1 \\ \lambda_2 \end{bmatrix} = \begin{bmatrix} L_{11} & L_{12} \\ L_{21} & L_{22} \end{bmatrix} \begin{bmatrix} i_1 \\ i_2 \end{bmatrix}$$

or

$$\begin{bmatrix} i_1 \\ i_2 \end{bmatrix} = \begin{bmatrix} \Gamma_{11} & \Gamma_{12} \\ \Gamma_{21} & \Gamma_{22} \end{bmatrix} \begin{bmatrix} \lambda_1 \\ \lambda_2 \end{bmatrix}$$

where $L_{12}=L_{21}$, $\Gamma_{11}=L_{22}/\Delta$, $\Gamma_{12}=\Gamma_{21}=-L_{12}/\Delta$, $\Gamma_{22}=L_{11}/\Delta$, and $\Delta=L_{11}L_{22}-L_{12}^2$. The magnetic energy and coenergy can then be expressed as

$$W_f(\lambda_1, \lambda_2, \theta) = \frac{1}{2} \Gamma_{11} \lambda_1^2 + \frac{1}{2} \Gamma_{22} \lambda_2^2 + \Gamma_{12} \lambda_1 \lambda_2$$

and

$$W_f'(i_1, i_2, \theta) = \frac{1}{2} L_{11} i_1^2 + \frac{1}{2} L_{22} i_2^2 + L_{12} i_1 i_2$$

respectively, and it can be shown that they are equal.

Therefore, the torque acting on the rotor can be calculated as

$$\begin{aligned} T &= - \frac{\partial W_f(\lambda_1, \lambda_2, \theta)}{\partial \theta} = \frac{\partial W_f'(i_1, i_2, \theta)}{\partial \theta} \\ &= \frac{1}{2} i_1^2 \frac{dL_{11}(\theta)}{d\theta} + \frac{1}{2} i_2^2 \frac{dL_{22}(\theta)}{d\theta} + i_1 i_2 \frac{dL_{12}(\theta)}{d\theta} \end{aligned}$$

Because of the salient (not round) structure of the rotor, the self inductance of the stator is a function of the rotor position and the first term on the right hand side of the above torque expression is nonzero for that $dL_{11}/d\theta \neq 0$. Similarly, the second term on the right hand side of the above torque expression is nonzero because of the salient structure of the stator. Therefore, these two terms are known as the reluctance torque component. The last term in the torque expression, however, is only related to the relative position of the stator and rotor and is independent of the shape of the stator and rotor poles.

Model of Electromechanical Systems

To illustrate the general principle for modeling of an electromechanical system, we still use the doubly excited rotating actuator discussed above as an example. For convenience, we plot it here again. As discussed in the introduction, the mathematical model of an electromechanical system consists of circuit equations for the electrical subsystem and force

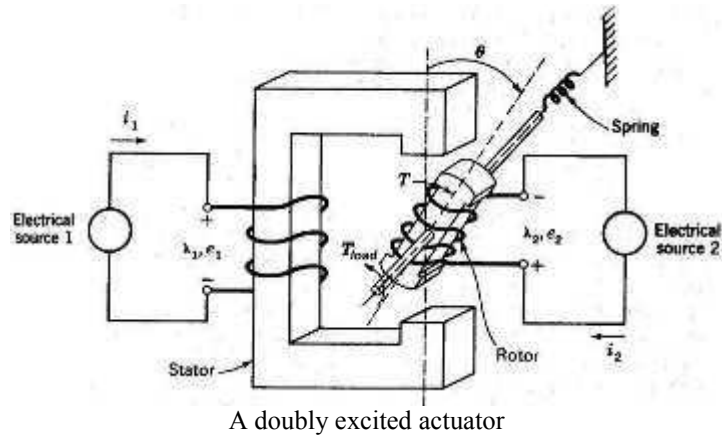

or torque balance equations for the mechanical subsystem, whereas the interactions between the two subsystems via the magnetic field can be expressed in terms of the *emf*'s and the electromagnetic force or torque. Thus, for the doubly excited rotating actuator, we can write

$$\begin{aligned}
 v_1 &= R_1 i_1 + \frac{d\lambda_{11}}{dt} = R_1 i_1 + \frac{d(\lambda_{11} + \lambda_{12})}{dt} \\
 &= R_1 i_1 + L_{11} \frac{di_1}{dt} + i_1 \frac{dL_{11}(\theta)}{d\theta} \frac{d\theta}{dt} + L_{12} \frac{di_2}{dt} + i_2 \frac{dL_{12}(\theta)}{d\theta} \frac{d\theta}{dt} \\
 &= \left[R_1 + \omega_r \frac{dL_{11}(\theta)}{d\theta} \right] i_1 + \omega_r \frac{dL_{12}(\theta)}{d\theta} i_2 + L_{11} \frac{di_1}{dt} + L_{12} \frac{di_2}{dt}
 \end{aligned}$$

$$\begin{aligned}
 v_2 &= R_2 i_2 + \frac{d\lambda_{22}}{dt} = R_2 i_2 + \frac{d(\lambda_{21} + \lambda_{22})}{dt} \\
 &= R_2 i_2 + L_{22} \frac{di_2}{dt} + i_2 \frac{dL_{22}(\theta)}{d\theta} \frac{d\theta}{dt} + L_{21} \frac{di_1}{dt} + i_1 \frac{dL_{21}(\theta)}{d\theta} \frac{d\theta}{dt} \\
 &= \omega_r \frac{dL_{21}(\theta)}{d\theta} i_1 + \left[R_2 + \omega_r \frac{dL_{22}(\theta)}{d\theta} \right] i_2 + L_{21} \frac{di_1}{dt} + L_{22} \frac{di_2}{dt}
 \end{aligned}$$

$$T - T_{load} = J \frac{d\omega_r}{dt}$$

and

where

$$\omega_r = \frac{d\theta}{dt}$$

is the angular speed of the rotor, T_{load} the load torque, and J the inertia of the rotor and the mechanical load which is coupled to the rotor shaft.

The above equations are nonlinear differential equations which can only be solved numerically. In the format of state equations, the above equations can be rewritten as

$$\frac{di_1}{dt} = -\frac{1}{L_{11}} \left[R_1 + \frac{dL(\theta)}{d\theta} \omega \right] i_1 - \frac{1}{L_{12}} \frac{dL(\theta)}{d\theta} \omega i_2 - \frac{L_{12}}{L_{11}} \frac{di_2}{dt} + \frac{1}{L_{11}} v_1$$

$$\frac{di_2}{dt} = -\frac{1}{L_{22}} \frac{dL(\theta)}{d\theta} \omega i_1 - \frac{1}{L_{22}} \left[R_2 + \frac{dL(\theta)}{d\theta} \omega \right] i_2 - \frac{L_{12}}{L_{22}} \frac{di_1}{dt} + \frac{1}{L_{22}} v_2$$

$$\frac{d\omega_r}{dt} = \frac{1}{J} T - \frac{1}{J_{load}} T$$

and $\frac{d\theta}{dt} = \omega_r$

Together with the specified initial conditions (the state of the system at time zero in terms of the state variables):

$$i_1 \Big|_{t=0} = i_{10}, i_2 \Big|_{t=0} = i_{20}, \omega_r \Big|_{t=0} = \omega_{r0}, \text{ and } \theta \Big|_{t=0} = \theta_0,$$

the above state equations can be used to simulate the dynamic performance of the doubly excited rotating actuator.

Following the same rule, we can derive the state equation model of any electromechanical systems.

KITS GUNTUR

DC GENERATOR

The electrical machines deals with the energy transfer either from mechanical to electrical form or from electrical to mechanical form, this process is called electromechanical energy conversion. An electrical machine which converts mechanical energy into electrical energy is called an electric generator while an electrical machine which converts electrical energy into the mechanical energy is called an electric motor. A DC generator is built utilizing the basic principle that emf is induced in a conductor when it cuts magnetic lines of force. A DC motor works on the basic principle that a current carrying conductor placed in a magnetic field experiences a force.

Working principle:

All the generators work on the principle of dynamically induced emf.

The change in flux associated with the conductor can exist only when there exists a relative motion between the conductor and the flux.

The relative motion can be achieved by rotating the conductor w.r.t flux or by rotating flux w.r.t conductor. So, a voltage gets generated in a conductor as long as there exists a relative motion between conductor and the flux. Such an induced emf which is due to physical movement of coil or conductor w.r.t flux or movement of flux w.r.t coil or conductor is called dynamically induced emf.

Whenever a conductor cuts magnetic flux, dynamically induced emf is produced in it according to Faraday's laws of Electromagnetic Induction.

This emf causes a current to flow if the conductor circuit is closed.

So, a generating action requires the following basic components to exist.

1. The conductor or a coil
2. Flux
3. Relative motion between the conductor and the flux.

In a practical generator, the conductors are rotated to cut the magnetic flux, keeping flux stationary. To have a large voltage as output, a number of conductors are connected together in a specific manner to form a winding. The winding is called armature winding of a dc machine and the part on which this winding is kept is called armature of the dc machine.

The magnetic field is produced by a current carrying winding which is called field winding.

The conductors placed on the armature are rotated with the help of some external device. Such an external device is called a prime mover.

The commonly used prime movers are diesel engines, steam engines, steam turbines, water turbines etc.

The purpose of the prime mover is to rotate the electrical conductor as required by Faraday's laws. The direction of induced emf can be obtained by using Flemings right hand rule.

The magnitude of induced emf = $e = BLV \sin\theta = E_m \sin\theta$

Nature of induced emf:

The nature of the induced emf for a conductor rotating in the magnetic field is alternating. As conductor rotates in a magnetic field, the voltage component at various positions is different. Hence the basic nature of induced emf in the armature winding in case of dc generator is alternating. To get dc output which is unidirectional, it is necessary to rectify the alternating induced emf. A device which is used in dc generator to convert alternating induced emf to unidirectional dc emf is called commutator.

Construction of DC machines :

A D. C. machine consists of two main parts

1. Stationary part: It is designed mainly for producing a magnetic flux.
2. Rotating part: It is called the armature, where mechanical energy is converted into electrical (electrical generate) or conversely electrical energy into mechanical (electric into)

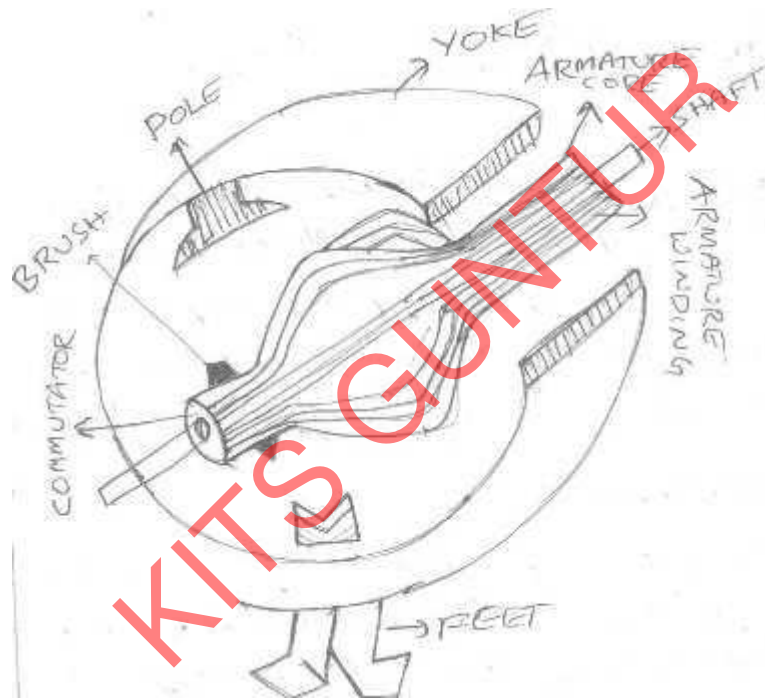

Parts of a Dc Generator:

- 1) Yoke
- 2) Magnetic Poles
 - a) Pole core
 - b) Pole Shoe
- 3) Field Winding
- 4) Armature Core
- 5) Armature winding
- 6) Commutator
- 7) Brushes and Bearings

The stationary parts and rotating parts are separated from each other by an air gap. The stationary part of a D. C. machine consists of main poles, designed to create the magnetic flux, commutating poles interposed between the main poles and designed to ensure spark less operation of the brushes at the commutator and a frame / yoke. The armature is a cylindrical body rotating in the space between the poles and comprising a slotted armature core, a winding inserted in the armature core slots, a commutator and brush

Yoke:

1. It saves the purpose of outermost cover of the dc machine so that the insulating materials get protected from harmful atmospheric elements like moisture, dust and various gases like SO₂, acidic fumes etc.
 2. It provides mechanical support to the poles.
 3. It forms a part of the magnetic circuit. It provides a path of low reluctance for magnetic flux.
- Choice of material: To provide low reluctance path, it must be made up of some magnetic material. It is prepared by using cast iron because it is the cheapest. For large machines rolled steel or cast steel, is used which provides high permeability i.e., low reluctance and gives good mechanical strength.

Poles: Each pole is divided into two parts

- a) pole core
- b) pole shoe

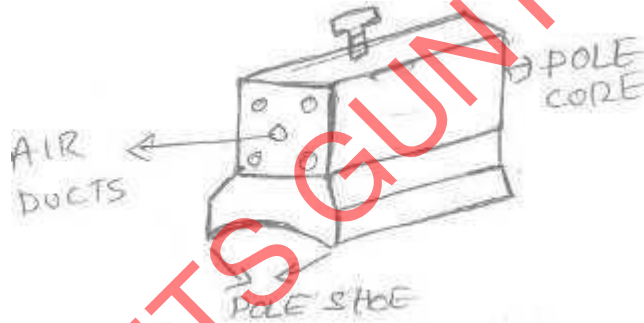

Functions:

1. Pole core basically carries a field winding which is necessary to produce the flux.
2. It directs the flux produced through air gap to armature core to the next pole.
3. Pole shoe enlarges the area of armature core to come across the flux, which is necessary to produce larger induced emf. To achieve this, pole core has been given a particular shape.

Choice of material: It is made up of magnetic material like cast iron or cast steel. As it requires a definite shape and size, laminated construction is used. The laminations of required size and shape are stamped together to get a pole which is then bolted to yoke.

Armature: It is further divided into two parts namely,

- (1) Armature core
- (2) Armature winding.

Armature core is cylindrical in shape mounted on the shaft. It consists of slots on its periphery and the air ducts to permit the air flow through armature which serves cooling purpose.

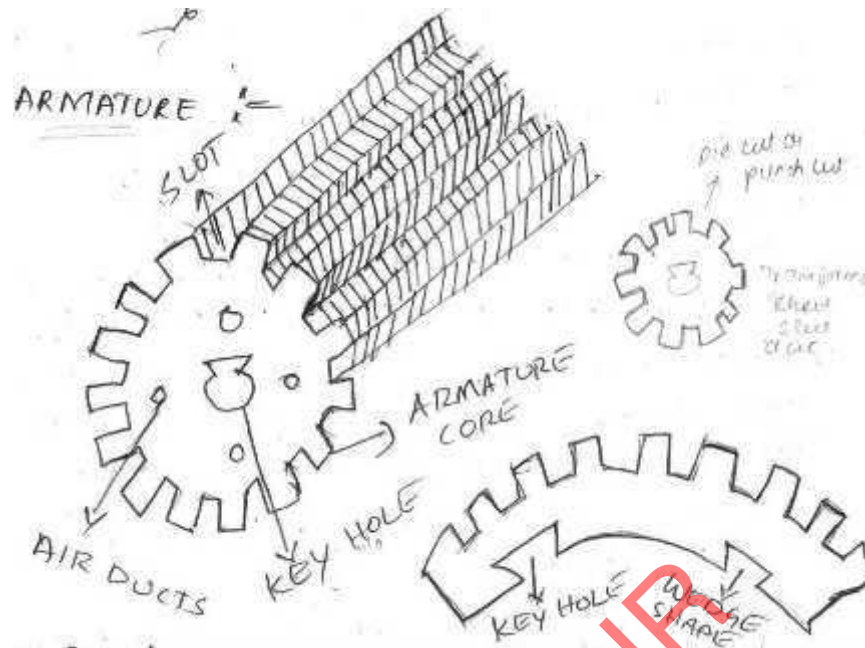

Functions:

1. Armature core provides house for armature winding i.e., armature conductors.
2. To provide a path of low reluctance path to the flux it is made up of magnetic material like cast iron or cast steel.

Choice of material: As it has to provide a low reluctance path to the flux, it is made up of magnetic material like cast iron or cast steel.

It is made up of laminated construction to keep eddy current loss as low as possible.

A single circular lamination used for the construction of the armature core is shown below.

2. **Armature winding:** Armature winding is nothing but the inter connection of the armature conductors, placed in the slots provided on the armature core. When the armature is rotated, in case of generator magnetic flux gets cut by armature conductors and emf gets induced in them.

Function:

1. Generation of emf takes place in the armature winding in case of generators.
2. To carry the current supplied in case of dc motors.
3. To do the useful work in the external circuit.

Choice of material : As armature winding carries entire current which depends on external load, it has to be made up of conducting material, which is copper.

Field winding: The field winding is wound on the pole core with a definite direction.

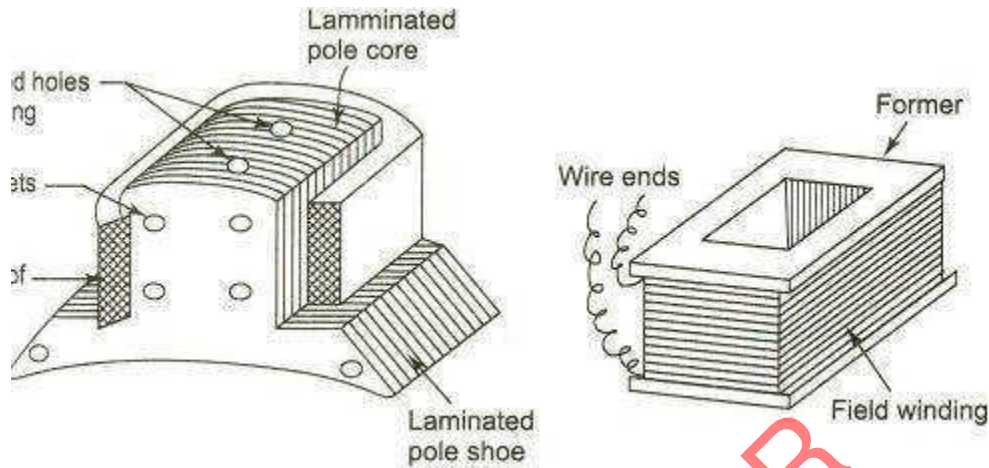

Functions: To carry current due to which pole core on which the winding is placed behaves as an electromagnet, producing necessary flux.

As it helps in producing the magnetic field i.e. exciting the pole as electromagnet it is called '**Field winding**' or '**Exciting winding**'.

Choice of material : As it has to carry current it should be made up of some conducting material like the aluminum or copper.

But field coils should take any type of shape should bend easily, so copper is the proper choice. Field winding is divided into various coils called as field coils. These are connected in series with each other and wound in such a direction around pole cores such that alternate N and S poles are formed.

Commutator: The rectification in case of dc generator is done by device called as commutator.

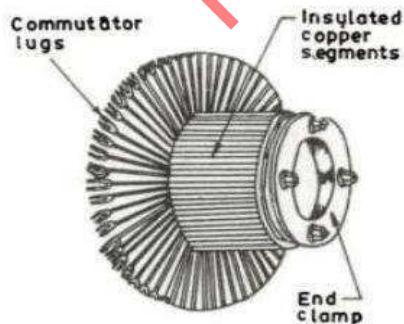

- Functions:
1. To facilitate the collection of current from the armature conductors.
 2. To convert internally developed alternating emf to in directional (dc) emf
 3. To produce unidirectional torque in case of motor.

Choice of material: As it collects current from armature, it is also made up of copper segments. It is cylindrical in shape and is made up of wedge shaped segments which are insulated from each other by thin layer of mica.

Brushes and brush gear: Brushes are stationary and rest on the surface of the Commutator. Brushes are rectangular in shape. They are housed in brush holders, which are usually of box type. The brushes are made to press on the commutator surface by means of a spring, whose tension can be adjusted with the help of lever. A flexible copper conductor called pigtail is used to connect the brush to the external circuit.

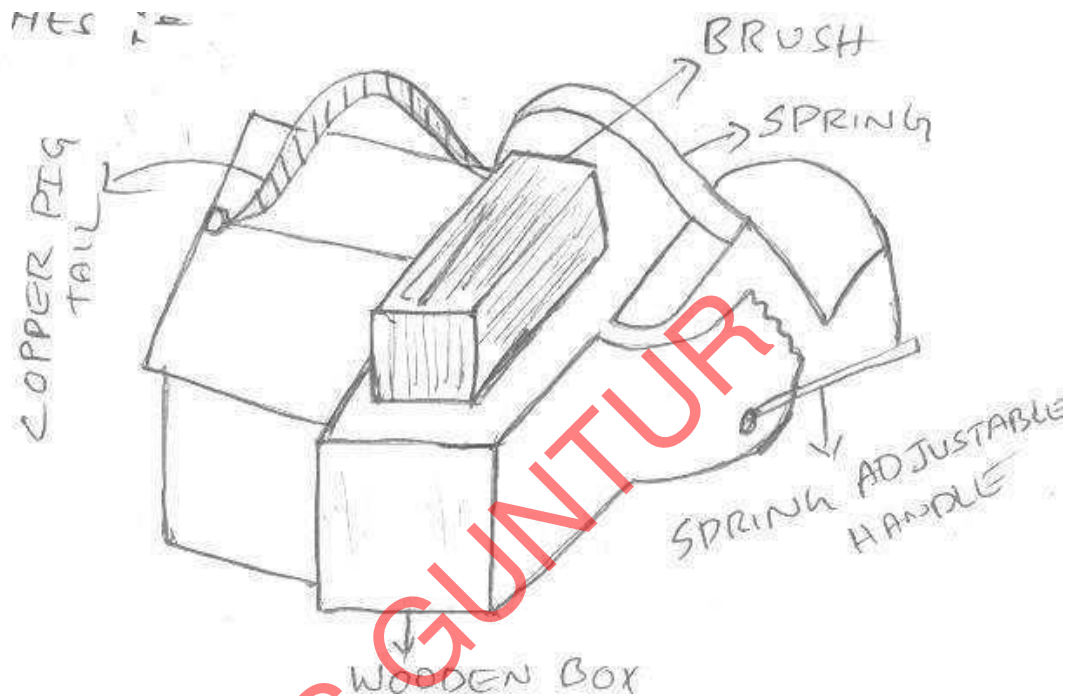

Functions: To collect current from commutator and make it available to the stationary external circuit.

Choice of material: Brushes are normally made up of soft material like carbon.

Bearings: Ball-bearings are usually used as they are more reliable. For heavy duty machines, roller bearings are preferred.

Working of DC generator:

The generator is provided with a magnetic field by sending dc current through the field coils mounted on laminated iron poles and through armature winding.

A short air gap separates the surface of the rotating armature from the stationary pole surface. The magnetic flux coming out of one or more north poles crossing the air gap, passes through the armature near the gap into one or more adjacent south poles.

The direct current leaves the generator at the positive brush, passes through the circuit and returns to the negative brush.

The terminal voltage of a dc generator may be increased by increasing the current in the field coil and may be reduced by decreasing the current.

Generators are generally run at practically constant speed by their prime movers.

Types of armature winding:

Armature conductors are connected in a specific manner called as armature winding and according to the way of connecting the conductors; armature winding is divided into two types.

Lap winding: In this case, if connection is started from conductor in slot 1 then the connections overlap each other as winding proceeds, till starting point is reached again.

There is overlapping of coils while proceeding. Due to such connection, the total number of conductors get divided into 'P' number of parallel paths, where

P = number of poles in the machine.

Large number of parallel paths indicates high current capacity of machine hence lap winding is pertained for high current rating generators.

Wave winding: In this type, winding always travels ahead avoiding over lapping. It travels like a progressive wave hence called wave winding.

Both coils starting from slot 1 and slot 2 are progressing in wave fashion.

Due to this type of connection, the total number of conductors get divided into two number of parallel paths always, irrespective of number of poles of machine.

As number of parallel paths is less, it is preferable for low current, high voltage capacity generators.

Sl. No.	Lap winding	Wave winding
1.	Number of parallel paths (A) = poles (P)	Number of parallel paths (A) = 2 (always)
2.	Number of brush sets required is equal to number of poles	Number of brush sets required is always equal to two
3.	Preferable for high current, low voltage capacity generators	Preferable for high current, low current capacity generators
4.	Normally used for generators of capacity more than 500 A	Preferred for generator of capacity less than 500 A.

EMF equation of a generator

Let P = number of poles

Φ = flux/pole in webers

Z = total number of armature conductors.

= number of slots x number of conductors/slot

N = armature rotation in revolutions (speed for armature) per minute (rpm)

A = No. of parallel paths into which the 'z' no. of conductors are divided.

E = emf induced in any parallel path

E_g = emf generated in any one parallel path in the armature.

Average emf generated/conductor = $d\Phi/dt$ volt

Flux current/conductor in one revolution

$$dt = d \times p$$

In one revolution, the conductor will cut total flux produced by all poles = $d \times p$

No. of revolutions/second = $N/60$

Therefore, Time for one revolution, $dt = 60/N$ second

According to Faraday's laws of Electromagnetic Induction, emf generated/conductor = $d\Phi/dt = \frac{d \times p \times N}{60}$ volts

This is emf induced in one conductor.

For a simplex wave-wound generator

No. of parallel paths = 2

No. of conductors in (series) in one path = $Z/2$

EMF generated/path = $\Phi PN/60 \times Z/2 = \Phi ZPN/120$ volt

For a simple lap-wound generator

Number of parallel paths = P

Number of conductors in one path = Z/P

EMF generated/path = $\Phi PN/60 (Z/P) = \Phi ZN/60$ A = 2 for simplex – wave winding

A = P for simplex lap-winding

Armature Reaction and Commutation

Introduction

In a d.c. generator, the purpose of field winding is to produce magnetic field (called main flux) whereas the purpose of armature winding is to carry armature current. Although the armature winding is not provided for the purpose of producing a magnetic field, nevertheless the current in the armature winding will also produce magnetic flux (called armature flux). The armature flux distorts and weakens the main flux posing problems for the proper operation of the d.c. generator. The action of armature flux on the main flux is called armature reaction.

2.1 Armature Reaction

So far we have assumed that the only flux acting in a d.c. machine is that due to the main poles called main flux. However, current flowing through armature conductors also creates a magnetic flux (called armature flux) that distorts and weakens the flux coming from the poles. This distortion and field weakening takes place in both generators and motors. The action of armature flux on the main flux is known as armature reaction.

The phenomenon of armature reaction in a d.c. generator is shown in Fig.(2.1)

Only one pole is shown for clarity. When the generator is on no-load, a small current flowing in the armature does not appreciably affect the main flux ϕ_1 coming from the pole [See Fig 2.1 (i)]. When the generator is loaded, the current flowing through armature conductors sets up flux ϕ_2 . Fig. (2.1) (ii) shows flux due to armature current alone. By superimposing ϕ_1 and ϕ_2 , we obtain the resulting flux ϕ_3 as shown in Fig. (2.1) (iii). Referring to Fig (2.1) (iii), it is clear that flux density at the trailing pole tip (point B) is increased while at the leading pole tip (point A) it is decreased. This unequal field distribution produces the following two effects:

The main flux is distorted.

Due to higher flux density at pole tip B, saturation sets in. Consequently, the increase in flux at pole tip B is less than the decrease in flux under pole tip A. Flux ϕ_3 at full load is, therefore, less than flux ϕ_1 at no load. As we shall see, the weakening of flux due to armature reaction depends upon the position of brushes.

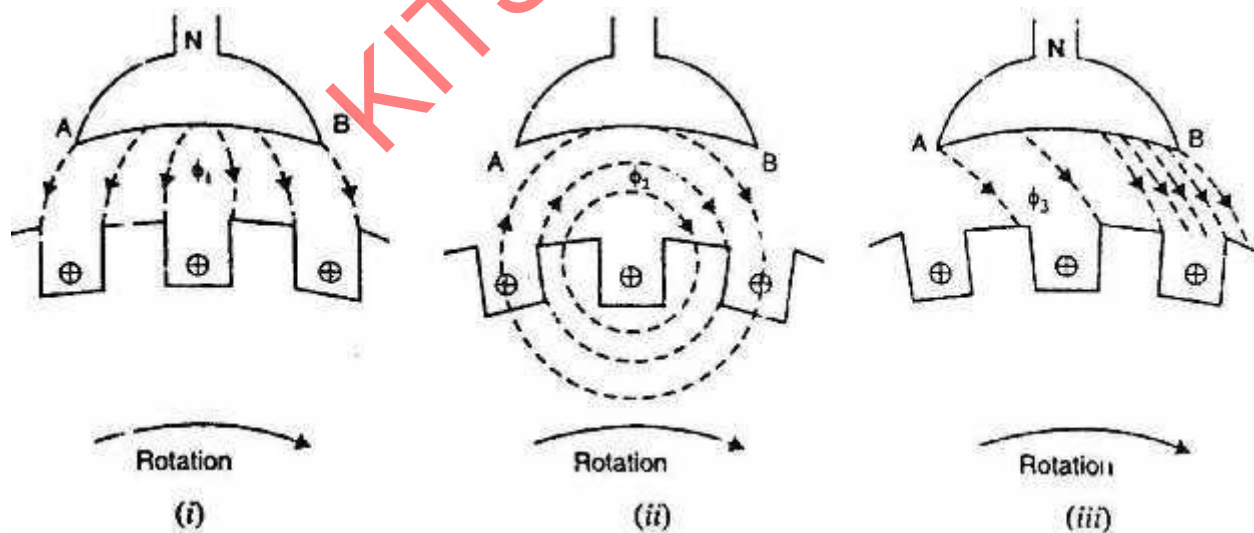

Fig. (2.1)

2.2 Geometrical and Magnetic Neutral Axes

4. The geometrical neutral axis (G.N.A.) is the axis that bisects the angle between the centre line of

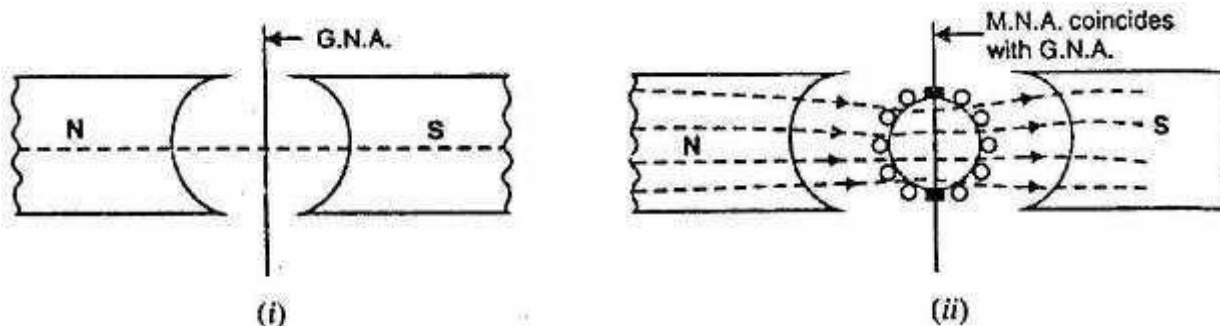

Fig. (2.2)

4. The magnetic neutral axis (M. N. A.) is the axis drawn perpendicular to the mean direction of the flux passing through the centre of the armature. Clearly, no e.m.f. is produced in the armature conductors along this axis because then they cut no flux. With no current in the armature conductors, the M.N.A. coincides with G, N. A. as shown in Fig. (2.2).
5. In order to achieve sparkless commutation, the brushes must lie along M.N.A.

2.3 Explanation of Armature Reaction

With no current in armature conductors, the M.N.A. coincides with G.N.A. However, when current flows in armature conductors, the combined action of main flux and armature flux shifts the M.N.A. from G.N.A. In case of a generator, the M.N.A. is shifted in the direction of rotation of the machine. In order to achieve sparkless commutation, the brushes have to be moved along the new M.N.A. Under such a condition, the armature reaction produces the following two effects:

1. It demagnetizes or weakens the main flux.
2. It cross-magnetizes or distorts the main flux.

Let us discuss these effects of armature reaction by considering a 2-pole generator (though the following remarks also hold good for a multipolar generator).

- (i) Fig. (2.3) (i) shows the flux due to main poles (main flux) when the armature conductors carry no current. The flux across the air gap is uniform. The m.m.f. producing the main flux is represented in magnitude and direction by the vector OF_m in Fig. (2.3) (i). Note that OF_m is perpendicular to G.N.A.
- (ii) Fig. (2.3) (ii) shows the flux due to current flowing in armature conductors alone (main poles unexcited). The armature conductors to the left of G.N.A. carry current "in" (\cdot) and those to the right carry current "out" (\odot). The direction of magnetic lines of force can be found by cork screw rule. It is clear that armature flux is directed downward parallel to the brush axis. The m.m.f. producing the armature flux is represented in magnitude and direction by the vector OFA in Fig. (2.3) (ii).
- (iii) Fig. (2.3) (iii) shows the flux due to the main poles and that due to current in armature conductors acting together. The resultant m.m.f. OF is the vector sum of OF_m and OFA as shown in Fig. (2.3) (iii). Since M.N.A. is always perpendicular to the resultant m.m.f., the M.N.A. is shifted through an angle q . Note that M.N.A. is shifted in the direction of rotation of the generator.
- (iv) In order to achieve sparkless commutation, the brushes must lie along the M.N.A. Consequently, the brushes are shifted through an angle q so as to lie along the new M.N.A. as shown in Fig. (2.3) (iv). Due to brush shift, the m.m.f. FA of the armature is also rotated through the same angle q . It is because some of the conductors which were earlier under N-pole now come under S-pole and vice-versa. The result is that armature m.m.f. FA will no longer be vertically downward but will be rotated in the direction of rotation through an angle q as shown in Fig. (2.3) (iv). Now FA can be resolved into

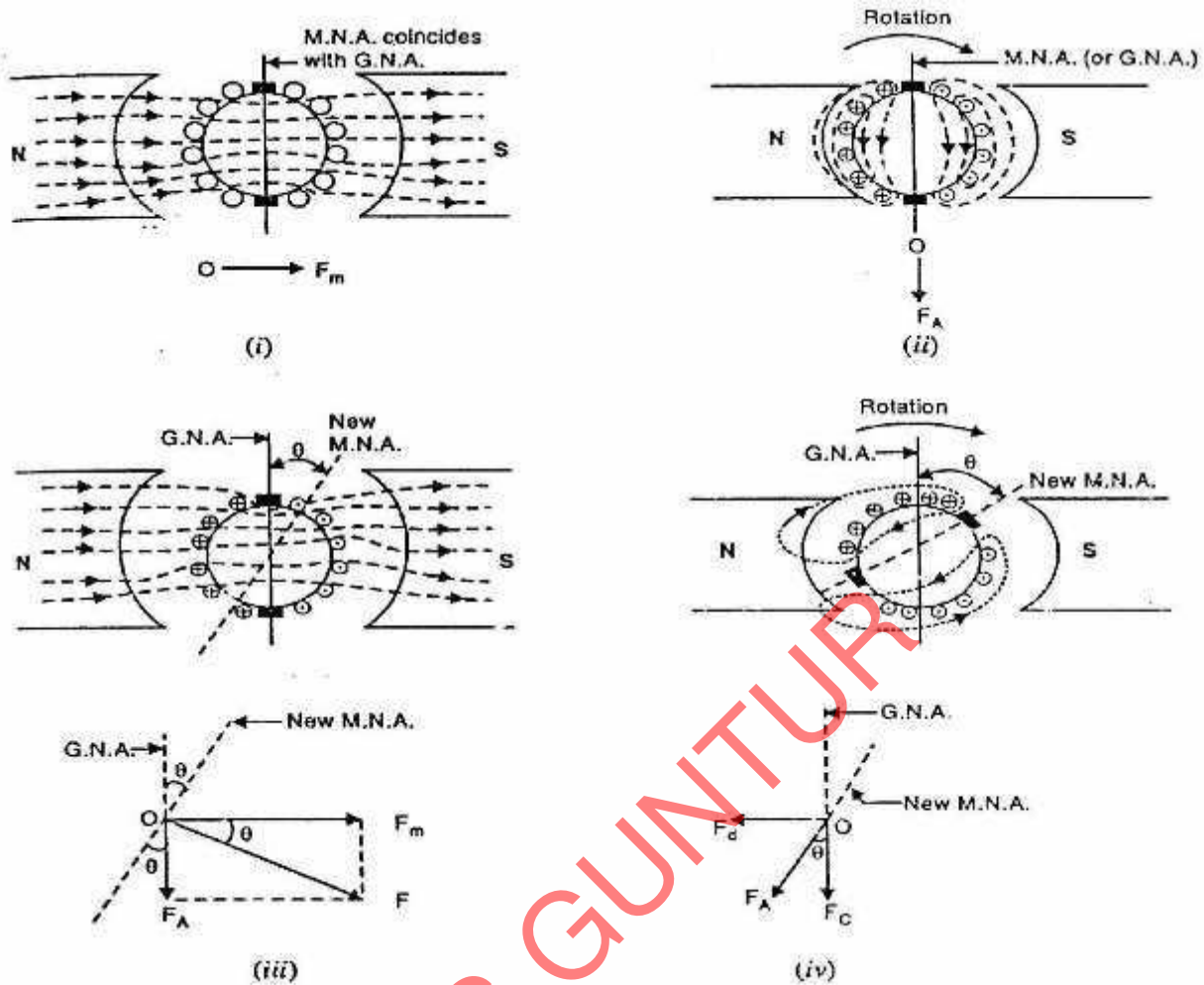

Fig. (2.3)

- (a) The component F_d is in direct opposition to the m.m.f. OF_m due to main poles. It has a demagnetizing effect on the flux due to main poles. For this reason, it is called the demagnetizing or weakening component of armature reaction.
- (b) The component F_c is at right angles to the m.m.f. OF_m due to main poles. It distorts the main field. For this reason, it is called the cross magnetizing or distorting component of armature reaction. It may be noted that with the increase of armature current, both demagnetizing and distorting effects will increase.

Conclusions

- (i) With brushes located along G.N.A. (i.e., $q = 0^\circ$), there is no demagnetizing component of armature reaction ($F_d = 0$). There is only distorting or cross magnetizing effect of armature reaction.
- (ii) With the brushes shifted from G.N.A., armature reaction will have both demagnetizing and distorting effects. Their relative magnitudes depend on the amount of shift. This shift is directly proportional to the Armature current.
- (iii) The demagnetizing component of armature reaction weakens the main flux. On the other hand, the distorting component of armature reaction distorts the main flux.
- (iv) The demagnetizing effect leads to reduced generated voltage while cross magnetizing effect leads to sparking at the brushes.

2.4 Demagnetizing and Cross-Magnetizing Conductors

With the brushes in the G.N.A. position, there is only cross-magnetizing effect of armature reaction. However, when the brushes are shifted from the G.N.A. position, the armature reaction will have both demagnetizing and cross magnetizing effects. Consider a 2-pole generator with brushes shifted (lead) θ_m mechanical degrees from G.N.A. We shall identify the armature conductors that produce demagnetizing effect and those that produce cross-magnetizing effect.

(i) The armature conductors θ_m on either side of G.N.A. produce flux in direct opposition to main flux as shown in Fig. (2.4) (i). Thus the conductors lying within angles $AOC = BOD = 2\theta_m$ at the top and bottom of the armature produce demagnetizing effect. These are called demagnetizing armature conductors and constitute the demagnetizing ampere-turns of armature reaction (Remember two conductors constitute a turn).

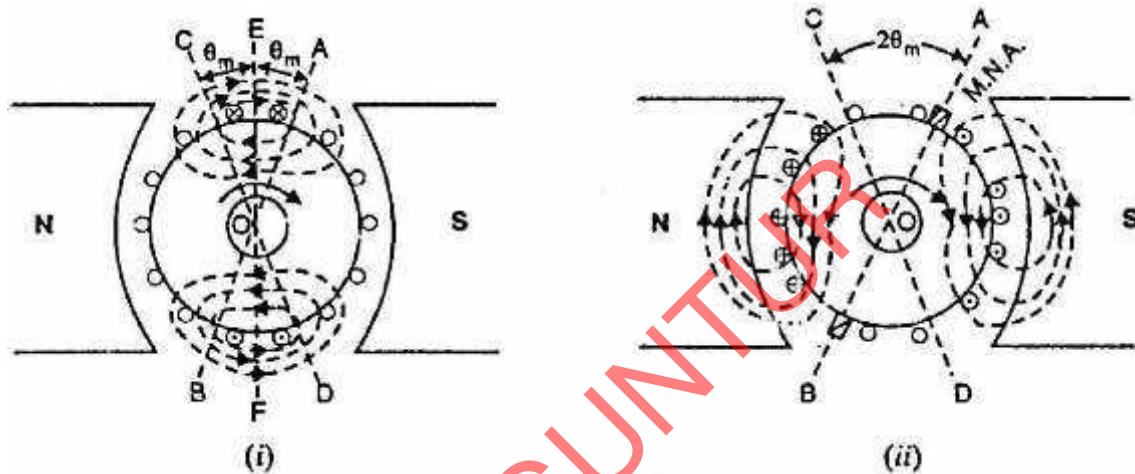

Fig.(2.4)

(ii) The axis of magnetization of the remaining armature conductors lying between angles AOD and COB is at right angles to the main flux as shown in Fig. (2.4) (ii). These conductors produce the cross-magnetizing (or distorting) effect i.e., they produce uneven flux distribution on each pole. Therefore, they are called cross-magnetizing conductors and constitute the cross-magnetizing ampere-turns of armature reaction.

2.5 Calculation of Demagnetizing Ampere-Turns Per Pole (ATd/Pole)

It is sometimes desirable to neutralize the demagnetizing ampere-turns of armature reaction. This is achieved by adding extra ampere-turns to the main field winding. We shall now calculate the demagnetizing ampere-turns per pole (ATd/pole).

Let Z	=	total number of armature conductors
I	=	current in each armature conductor
	=	$I_a/2$
	=	... for simplex wave winding
	=	I_a/P
	=	... for simplex lap winding
θ_m	=	forward lead in mechanical degrees

Referring to Fig. (2.4) (i) above, we have,
Total demagnetizing armature conductors

$$= \text{Conductors in angles AOC and BOD} = \frac{4\theta_m}{360} \times Z$$

Since two conductors constitute one turn,

$$\therefore \text{Total demagnetizing ampere-turns} = \frac{1}{2} \left| \frac{4\theta_m}{360} \times Z \right| \times I = \frac{2\theta_m}{360} \times ZI$$

These demagnetizing ampere-turns are due to a pair of poles.

$$\therefore \text{Demagnetizing ampere-turns/pole} = \frac{\theta_m}{360} \times ZI$$

i.e., $AT_d / \text{pole} = \frac{\theta_m}{360} \times ZI$

As mentioned above, the demagnetizing ampere-turns of armature reaction can be neutralized by putting extra turns on each pole of the generator.

$$\therefore \text{No. of extra turns/pole} = \frac{AT_d}{I_{sh}} \quad \text{for a shunt generator}$$

$$= \frac{AT_d}{I_a} \quad \text{for a series generator}$$

Note. When a conductor passes a pair of poles, one cycle of voltage is generated. We say one cycle contains 360 electrical degrees. Suppose there are P poles in a generator. In one revolution, there are 360 mechanical degrees and $360 \times P/2$ electrical degrees.

$$\therefore 360^\circ \text{ mechanical} = 360 \times \frac{P}{2} \text{ electrical degrees}$$

or $1^\circ \text{ Mechanical} = \frac{P}{2} \text{ electrical degrees}$

$$\therefore \theta \text{ (mechanical)} = \frac{\theta \text{ (electrical)}}{\text{Pair of poles}}$$

or $\theta_m = \frac{\theta_e}{P/2} \quad \therefore \theta_m = \frac{2\theta_e}{P}$

2.6 Cross-Magnetizing Ampere-Turns Per Pole (ATc/Pole)

We now calculate the cross-magnetizing ampere-turns per pole (ATc/pole).

Total armature reaction ampere-turns per pole

$$= \frac{Z/2}{P} \times I - \frac{Z}{2P} \times I \quad (\because \text{two conductors make one turn})$$

Demagnetizing ampere-turns per pole is given by:

$$AT_d / \text{pole} = \frac{\theta_m}{360} \times ZI$$

(found as above)

Cross-magnetizing ampere-turns/pole are

$$AT_c / \text{pole} = \frac{Z}{2P} \times I - \frac{\theta_m}{360} \times ZI = ZI \left(\frac{1}{2P} - \frac{\theta_m}{360} \right)$$

$$\therefore AT_c / \text{pole} = ZI \left(\frac{1}{2P} - \frac{\theta_m}{360} \right)$$

2.7 Compensating Windings

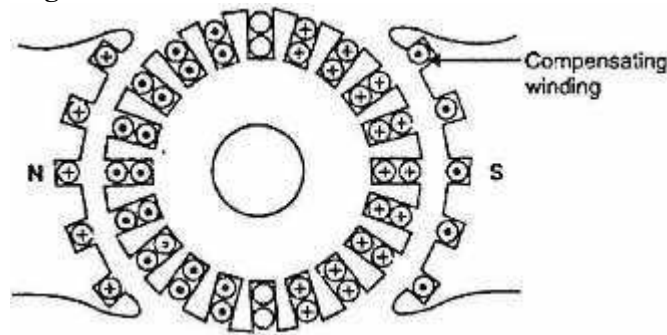

Fig. (2.5)

The cross-magnetizing effect of armature reaction may cause trouble in d.c. machines subjected to large fluctuations in load. In order to neutralize the cross magnetizing effect of armature reaction, a compensating winding is used. A compensating winding is an auxiliary winding embedded in slots in the pole faces as shown in Fig. (2.5). It is connected in series with armature in a manner so that the direction of current through the compensating conductors in any one pole face will be opposite to the direction of the current through the adjacent armature conductors [See Fig. 2.5].

Let us now calculate the number of compensating conductors/ pole face. In calculating the conductors per pole face required for the compensating winding, it should be remembered that the current in the compensating conductors is the armature current I_a whereas the current in armature conductors is I_a/A where A is the number of parallel paths.

Let	Z_c	=	No. of compensating conductors/pole face
	Z_a	=	No. of active armature conductors
	I_a	=	Total armature current
	I_a/A	=	Current in each armature conductor

$$\therefore Z_c I_a = Z_a \times \frac{I_a}{A}$$

or $Z_c = \frac{Z_a}{A}$

The use of a compensating winding considerably increases the cost of a machine and is justified only for machines intended for severe service e.g., for high speed and high voltage machines.

2.8 AT/Pole for Compensating Winding

Only the cross-magnetizing ampere-turns produced by conductors under the pole face are effective in producing the distortion in the pole cores. If Z is the total number of armature conductors and P is the number of poles, then,

$$\text{No. of armature conductors/pole} = \frac{Z}{P}$$

$$\text{No. of armature turns/pole} = \frac{Z}{2P}$$

$$\text{No. of armature turns under pole face} = \frac{Z}{2P} \times \frac{\text{Pole arc}}{\text{Pole pitch}}$$

If I is the current through each armature conductor, then,

$$\text{AT/pole required for compensating winding} = \frac{ZI}{2P} \times \frac{\text{Pole arc}}{\text{Pole pitch}}$$

$$= \text{Armature AT/pole} \times \frac{\text{Pole arc}}{\text{Pole pitch}}$$

2.9 Commutation

Fig. (2.6) shows the schematic diagram of 2-pole lap-wound generator. There are two parallel paths between the brushes. Therefore, each coil of the winding carries one half ($I_a/2$ in this case) of the total current (I_a) entering or leaving the armature.

Note that the currents in the coils connected to a brush are either all towards the brush (positive brush) or all directed away from the brush (negative brush). Therefore, current in a coil will reverse as the coil passes a brush. This reversal of current as the coil passes & brush is called commutation.

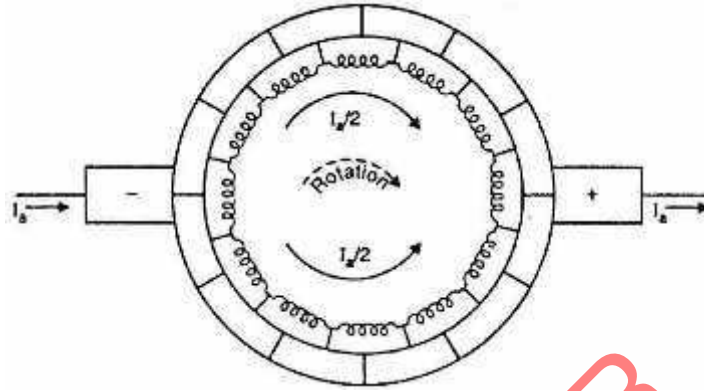

Fig. (2.6)

The reversal of current in a coil as the coil passes the brush axis is called commutation. When commutation takes place, the coil undergoing commutation is short circuited by the brush. The brief period during which the coil remains short circuited is known as commutation period T_c . If the current reversal is completed by the end of commutation period, it is called ideal commutation. If the current reversal is not completed by that time, then sparking occurs between the brush and the commutator which results in progressive damage to both.

Ideal commutation

Let us discuss the phenomenon of ideal commutation (i.e., coil has no inductance) in one coil in the armature winding shown in Fig. (2.6) above. For this purpose, we consider the coil A. The brush width is equal to the width of one commutator segment and one mica insulation. Suppose the total armature current is 40 A. Since there are two parallel paths, each coil carries a current of 20 A.

- (i) In Fig. (2.7) (i), the brush is in contact with segment 1 of the commutator. The commutator segment 1 conducts a current of 40 A to the brush; 20 A from coil A and 20 A from the adjacent coil as shown. The coil A has yet to undergo commutation.
- (ii) As the armature rotates, the brush will make contact with segment 2 and thus short-circuits the coil A as shown in Fig. (2.7) (ii). There are now two parallel paths into the brush as long as the short-circuit of coil A exists. Fig. (2.7) (ii) shows the instant when the brush is one-fourth on segment 2 and three-fourth on segment 1. For this condition, the resistance of the path through segment 2 is three times the resistance of the path through segment 1 (Q contact resistance varies inversely as the area of contact of brush with the segment). The brush again conducts a current of 40 A; 30 A through segment 1 and 10 A through segment 2. Note that current in coil A (the coil undergoing commutation) is reduced from 20 A to 10 A.
- (iii) Fig. (2.7) (iii) shows the instant when the brush is one-half on segment 2 and one-half on segment 1. The brush again conducts 40 A; 20 A through segment 1 and 20 A through segment 2 (Q now the resistances of the two parallel paths are equal). Note that now, current in coil A is zero.
- (iv) Fig. (2.7) (iv) shows the instant when the brush is three-fourth on segment 2 and one-fourth on segment 1. The brush conducts a current of 40 A; 30 A through segment 2 and 10 A through segment 1. Note that current in coil A is 10 A but in the reverse direction to that before the start of commutation. The reader may see the action of the commutator in

- (v) Fig. (2.7) (v) shows the instant when the brush is in contact only with segment 2. The brush again conducts 40 A; 20 A from coil A and 20 A from the adjacent coil to coil A. Note that now current in coil A is 20 A but in the reverse direction. Thus the coil A has undergone commutation. Each coil undergoes commutation in this way as it passes the brush axis. Note that during commutation, the coil under consideration remains short circuited by the brush.

Fig. (2.8) shows the current-time graph for the coil A undergoing commutation. The horizontal line AB represents a constant current of 20 A upto the beginning of commutation. From the finish of commutation, it is represented by another horizontal line CD on the opposite side of the zero line and the same distance from it as AB i.e., the current has exactly reversed (- 20 A). The way in which current changes from B to C depends upon the conditions under which the coil undergoes commutation. If the current changes at a uniform rate (i.e., BC is a straight line), then it is called ideal commutation as shown in Fig. (2.8). Under such conditions, no sparking will take place between the brush and the commutator.

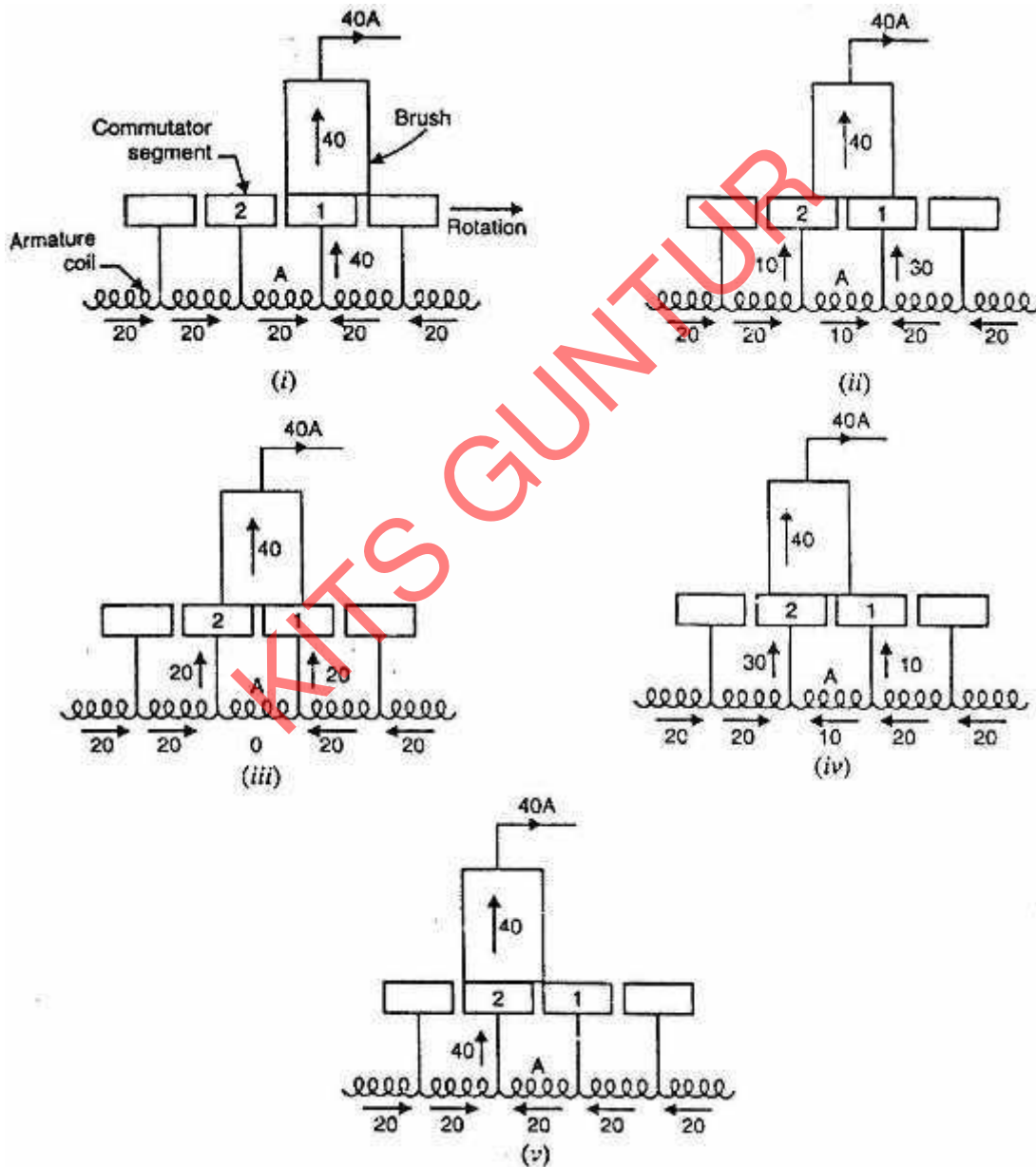

Fig. (2.7)

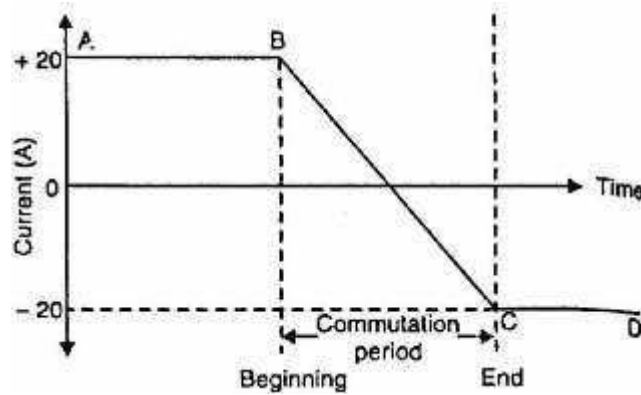

Fig. (2.8)

Practical difficulties

The ideal commutation (i.e., straight line change of current) cannot be attained in practice. This is mainly due to the fact that the armature coils have appreciable inductance. When the current in the coil undergoing commutation changes, self-induced e.m.f. is produced in the coil. This is generally called reactance voltage. This reactance voltage opposes the change of current in the coil undergoing commutation. The result is that the change of current in the coil undergoing commutation occurs more slowly than it would be under ideal commutation.

This is illustrated in Fig. (2.9). The straight line RC represents the ideal commutation whereas the curve BE represents the change in current when self-inductance of the coil is taken into account. Note that current CE (= 8A in Fig. 2.9) is flowing from the commutator segment 1 to the brush at the instant when they part company. This results in sparking just as when any other current carrying circuit is broken. The sparking results in overheating of commutators brush contact and causing damage to both.

Fig. (2.10) illustrates how sparking takes place between the commutators segment and the brush. At the end of commutation or short-circuit period, the current in coil A is reversed to a value of 12 A (instead of 20 A) due to inductance of the coil. When the brush breaks contact with segment 1, the remaining 8 A current jumps from segment 1 to the brush through air causing sparking between segment 1 and the brush.

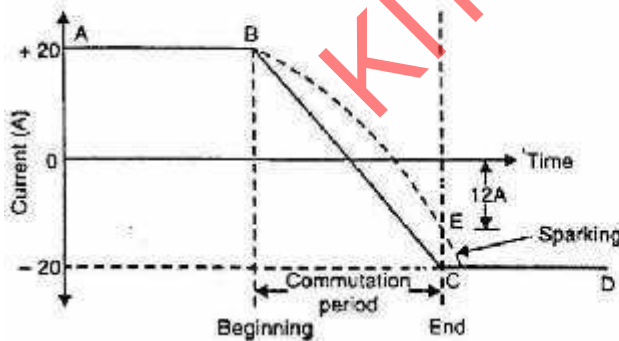

Fig. (2.9)

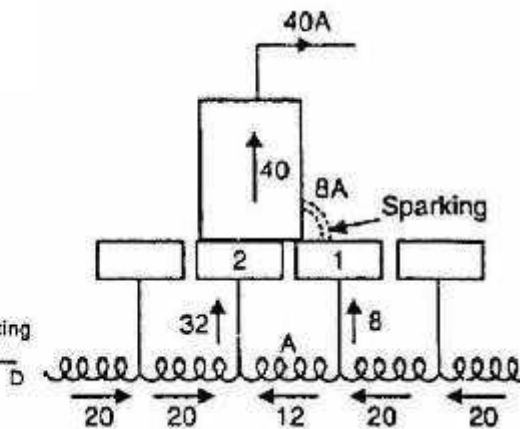

Fig. (2.10)

2.10 Calculation of Reactance Voltage

Reactance voltage = Coefficient of self-inductance *Rate of change of current

When a coil undergoes commutation, two commutator segments remain short circuited by the brush. Therefore, the time of short circuit (or commutation period T_c) is equal to the time required by the commutator to move a distance equal to the circumferential thickness of the brush minus the thickness of one insulating strip of mica

Let W_b = brush width in cm;
 W_m = mica thickness in cm
 v = peripheral speed of commutator in cm/s

$$\therefore \text{Commutation period, } T_c = \frac{W_b - W_m}{v} \text{ seconds}$$

The commutation period is very small, say of the order of 1/500 second.

Let the current in the coil undergoing commutation change from + I to - I (amperes) during the commutation. If L is the inductance of the coil, then reactance voltage is given by;

$$\text{Reactance voltage, } E_R = L \cdot 2I / T_c$$

2.11 Methods of Improving Commutation

Improving commutation means to make current reversal in the short-circuited coil as sparkless as possible. The following are the two principal methods of improving commutation:

- (i) Resistance commutation
- (ii) E.M.F. commutation

2.12 Resistance Commutation

The reversal of current in a coil (i.e., commutation) takes place while the coil is short-circuited by the brush. Therefore, there are two parallel paths for the current as long as the short circuit exists. If the contact resistance between the brush and the commutator is made large, then current would divide in the inverse ratio of contact resistances (as for any two resistances in parallel). This is the key point in improving commutation. This is achieved by using carbon brushes (instead of Cu brushes) which have high contact resistance. This method of improving commutation is called resistance commutation. Figs. (2.11) and (2.12) illustrates how high contact resistance of carbon brush improves commutation (i.e., reversal of current) in coil A.

In Fig. (2.11) (i), the brush is entirely on segment 1 and, therefore, the current in coil A is 20 A. The coil A is yet to undergo commutation. As the armature rotates, the brush short circuits the coil A and there are two parallel paths for the current into the brush.

Fig. (2.11) (ii) shows the instant when the brush is one-fourth on segment 2 and three-fourth on segment 1. The equivalent electric circuit is shown in Fig. (2.11) (iii) where R1 and R2 represent the brush contact resistances on segments 1 and 2. A resistor is not shown for coil A since it is assumed that the coil resistance is negligible as compared to the brush contact resistance

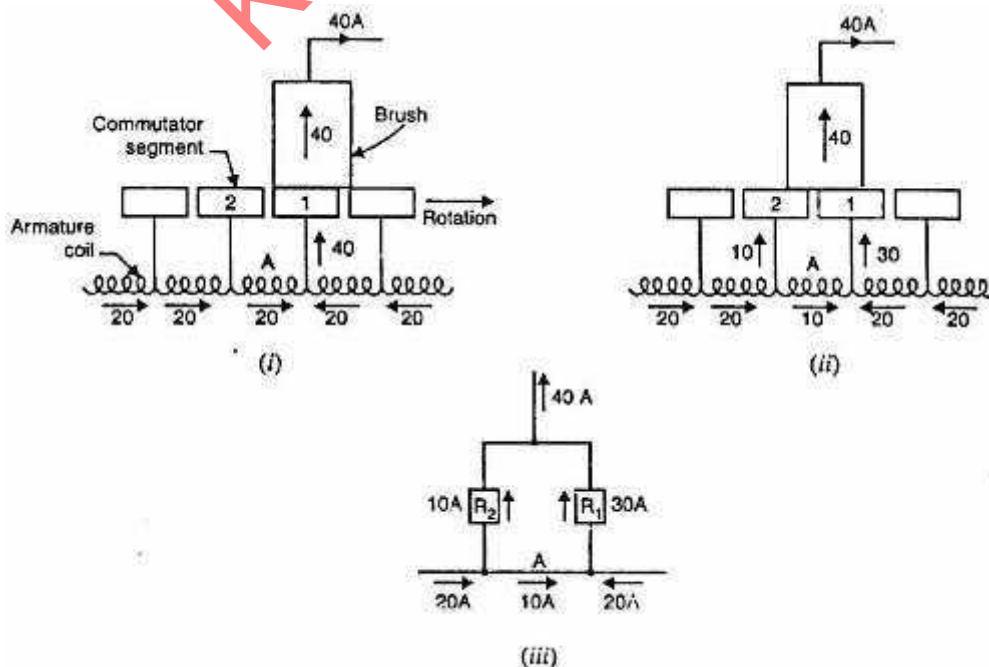

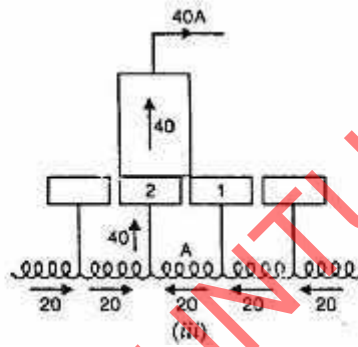
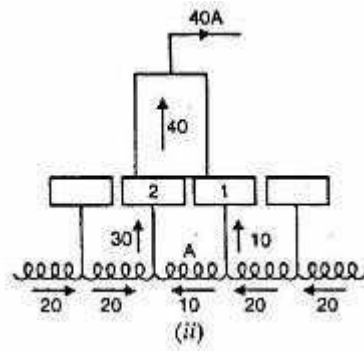
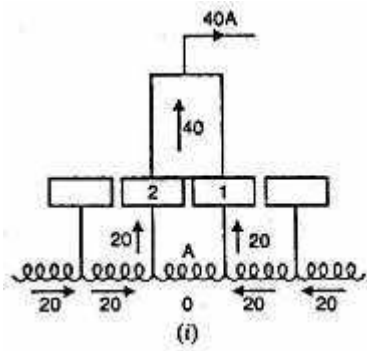

KITS GUNTUR

The values of current in the parallel paths of the equivalent circuit are determined by the respective resistances of the paths. For the condition shown in Fig. (2.11) (ii), resistor R2 has three times the resistance of resistor R1. Therefore, the current distribution in the paths will be as shown. Note that current in coil A is reduced from 20 A to 10 A due to division of current in the inverse ratio of contact resistances. If the Cu brush is used (which has low contact resistance), R1, R2 and the current in coil A would not have reduced to 10 A.

As the carbon brush passes over the commutator, the contact area with segment 2 increases and that with segment 1 decreases i.e., R2 decreases and R1 increases. Therefore, more and more current passes to the brush through segment 2. This is illustrated in Figs. (2.12) (i) and (2.12) (ii). When the break between the brush and the segment 1 finally occurs [See Fig. 2.12 (iii)], the current in the coil is reversed and commutation is achieved. It may be noted that the main cause of sparking during commutation is the production of reactance voltage and carbon brushes cannot prevent it.

Nevertheless, the carbon brushes do help in improving commutation. The other minor advantages of carbon brushes are:

(i) The carbon lubricates and polishes the commutator.

(ii) If sparking occurs, it damages the commutator less than with copper brushes and the damage to the brush itself is of little importance.

2.13 E.M.F. Commutation

In this method, an arrangement is made to neutralize the reactance voltage by producing a reversing voltage in the coil undergoing commutation. The reversing voltage acts in opposition to the reactance voltage and neutralizes it to some extent. If the reversing voltage is equal to the reactance voltage, the effect of the latter is completely wiped out and we get sparkless commutation. The reversing voltage may be produced in the following two ways:

(i) By brush shifting

(ii) By using interpoles or compoles

(i) By brush shifting

In this method, the brushes are given sufficient forward lead (for a generator) to bring the short-circuited coil (i.e., coil undergoing commutation) under the influence of the next pole of opposite polarity. Since the short-circuited coil is now in the reversing field, the reversing voltage produced cancels the reactance voltage. This method suffers from the following drawbacks:

(a) The reactance voltage depends upon armature current. Therefore, the brush shift will depend on the magnitude of armature current which keeps on changing. This necessitates frequent shifting of brushes.

(b) The greater the armature current, the greater must be the forward lead for a generator. This increases the demagnetizing effect of armature reaction and further weakens the main field.

(ii) By using interpoles or compoles

The best method of neutralizing reactance voltage is by using interpoles or compoles.

2.14 Interpoles or Compoles

The best way to produce reversing voltage to neutralize the reactance voltage is by using interpoles or compoles. These are small poles fixed to the yoke and spaced mid-way between the main poles (See Fig. 2.13). They are wound with comparatively few turns and connected in series with the armature so that they carry armature current. Their polarity is the same as the next main pole ahead in the direction of rotation for a generator (See Fig. 2.13). Connections for a d.c. generator with interpoles is shown in Fig. (2.14).

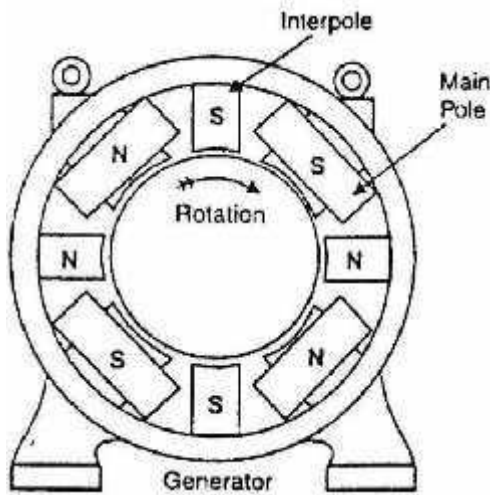

Fig. (2.13)

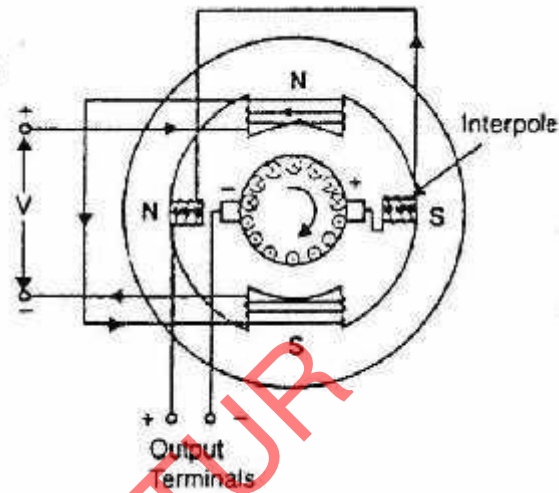

Fig. (2.14)

Functions of Interpoles

The machines fitted with interpoles have their brushes set on geometrical neutral axis (no lead). The interpoles perform the following two functions:

(i) As their polarity is the same as the main pole ahead (for a generator), they induce an e.m.f. in the coil (undergoing commutation) which opposes reactance voltage. This leads to sparkless commutation. The e.m.f. induced by compoles is known as commutating or reversing e.m.f. Since the interpoles carry the armature current and the reactance voltage is also proportional to armature current, the neutralization of reactance voltage is automatic.

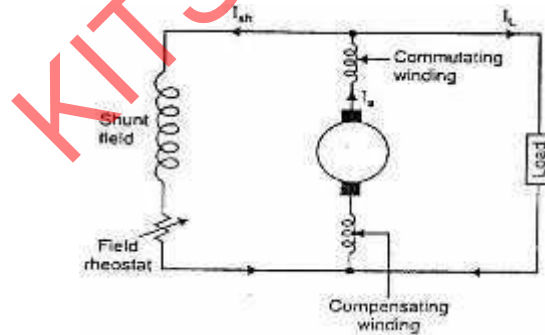

Fig. (2.15)

(ii) The m.m.f. of the compoles neutralizes the cross-magnetizing effect of armature reaction in small region in the space between the main poles. It is because the two m.m.f.s oppose each other in this region. Fig. (2.15) shows the circuit diagram of a shunt generator with commutating winding and compensating winding. Both these windings are connected in series with the armature and so they carry the armature current. However, the functions they perform must be understood clearly. The main function of commutating winding is to produce reversing (or commutating) e.m.f. in order to cancel the reactance voltage. In addition to this, the m.m.f. of the commutating winding neutralizes the cross magnetizing ampere-turns in the space between the main poles. The compensating winding neutralizes the cross-magnetizing effect of armature reaction under the pole faces.

KITS GUNTUR

TYPES OF DC GENERATORS

Permanent Magnet DC Generator:

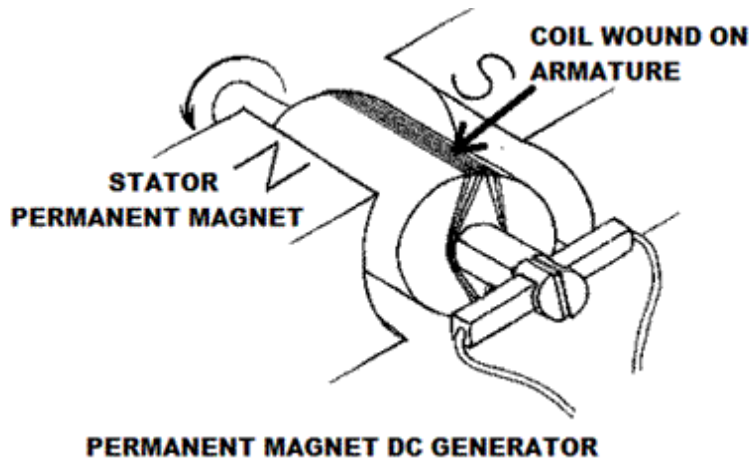

When the flux in the magnetic circuit is established by the help of permanent magnets then it is known as Permanent magnet dc generator. It consists of an armature and one or several permanent magnets situated around the armature. This type of dc generators generates very low power. So, they are rarely found in industrial applications. They are normally used in small applications like dynamos in motor cycles.

Separately Excited DC Generator

These are the generators whose field magnets are energized by some external dc source such as battery . A circuit diagram of separately excited DC generator is shown in figure.

I_a = Armature current I_L = Load current V = Terminal voltage E_g = Generated emf

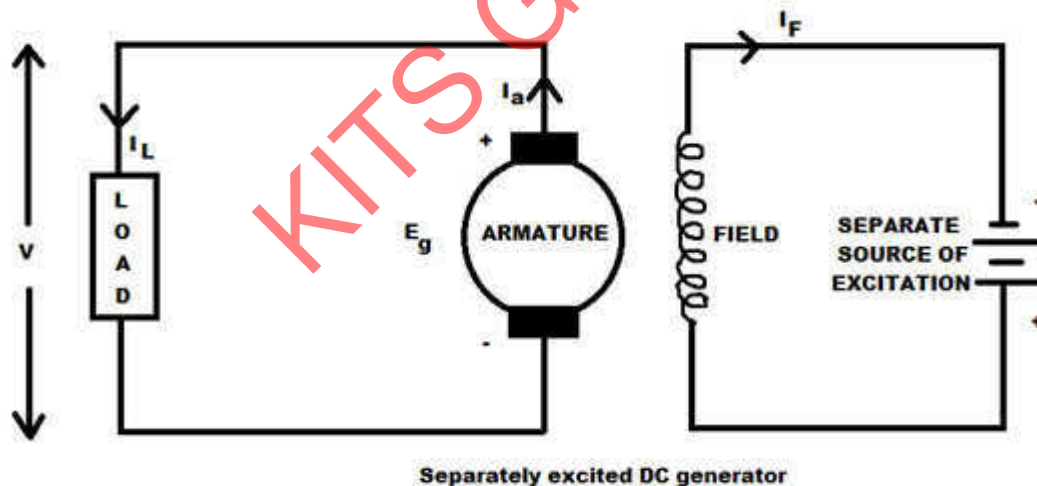

Voltage drop in the armature = $I_a \times R_a$ (R_a is the armature resistance) Let, $I_a = I_L = I$ (say) Then, voltage across the load, $V = IR_a$ Power generated, $P_g = E_g \times I$ Power delivered to the external load, $P_L = V \times I$.

Self-excited DC Generators

These are the generators whose field magnets are energized by the current supplied by themselves. In these type of machines field coils are internally connected with the armature. Due to residual magnetism some flux is always present in the poles. When the armature is rotated some emf is induced. Hence some induced current is produced. This small current flows through the field coil as well as the load and

thereby strengthening the pole flux. As the pole flux strengthened, it will produce more armature emf, which cause further increase of current through the field. This increased field current further raises armature emf and this cumulative phenomenon continues until the excitation reaches to the rated value. According to the position of the field coils the Self-excited DC generators may be classified as...

A. Series wound generators B. Shunt wound generators C. Compound wound generators

Series Wound Generator

In these type of generators, the field windings are connected in series with armature conductors as shown in figure below. So, whole current flows through the field coils as well as the load. As series field winding carries full load current it is designed with relatively few turns of thick wire. The electrical resistance of series field winding is therefore very low (nearly 0.5Ω). Let, R_{sc} = Series winding resistance I_{sc} = Current flowing through the series field R_a = Armature resistance I_a = Armature current I_L = Load current V = Terminal voltage E_g = Generated emf

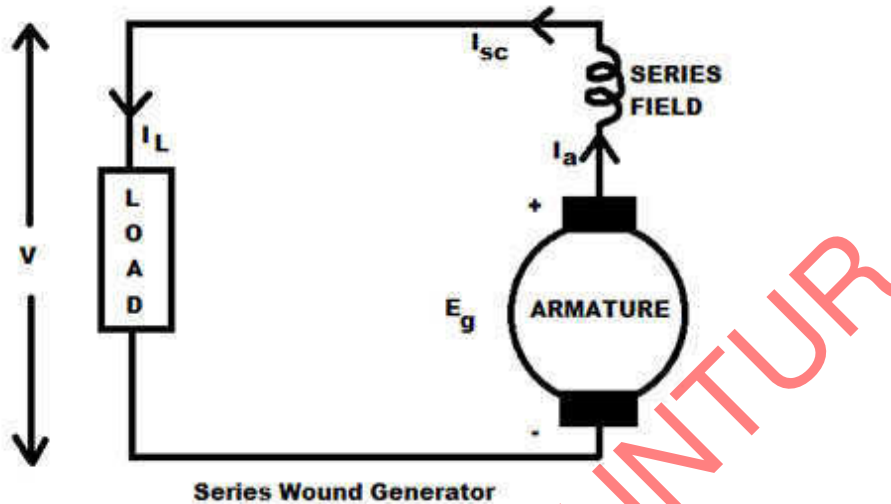

Then, $I_a = I_{sc} = I_L = I$ (say) Voltage across the load, $V = E_g - I(I_a \times R_a)$ Power generated, $P_g = E_g \times I$ Power delivered to the load, $P_L = V \times I$

Shunt Wound DC Generators

In these type of DC generators the field windings are connected in parallel with armature conductors as shown in figure below. In shunt wound generators the voltage in the field winding is same as the voltage across the terminal. Let, R_{sh} = Shunt winding resistance I_{sh} = Current flowing through the shunt field R_a = Armature resistance I_a = Armature current I_L = Load current V = Terminal voltage E_g = Generated emf

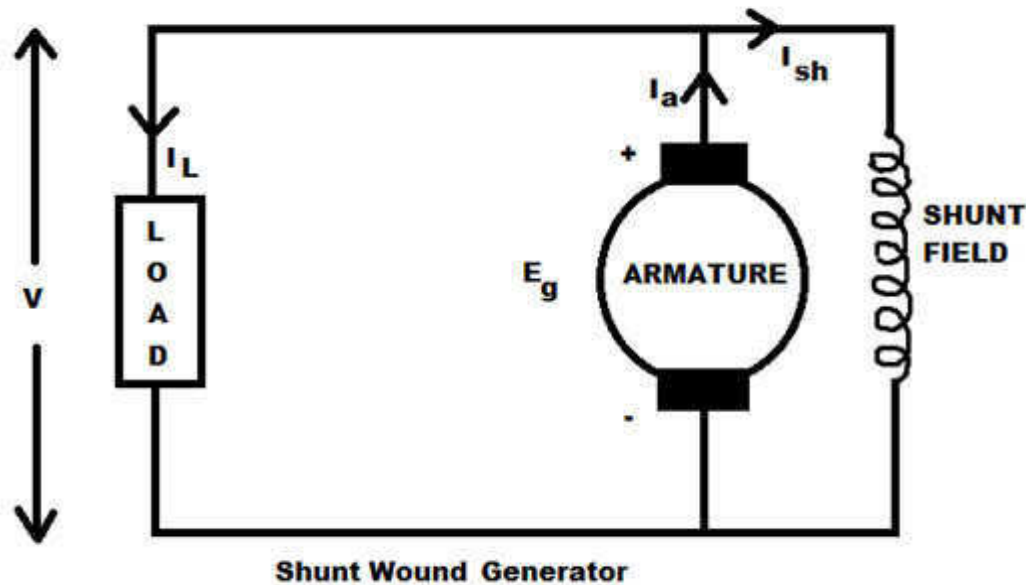

Here armature current I_a is dividing in two parts, one is shunt field current I_{sh} and another is load current I_L . So, $I_a = I_{sh} + I_L$. The effective power across the load will be maximum when I_L will be maximum. So, it is required to keep shunt field current as small as possible. For this purpose the resistance of the shunt field winding generally kept high (100Ω) and large no of turns are used for the desired emf. Shunt field current, $I_{sh} = V/R_{sh}$ Voltage across the load, $V = E_g - I_a R_a$ Power generated, $P_g = E_g \times I_a$ Power delivered to the load, $P_L = V \times I_L$

Compound Wound DC Generator

In series wound generators, the output voltage is directly proportional with load current. In shunt wound generators, output voltage is inversely proportional with load current. A combination of these two types of generators can overcome the disadvantages of both. This combination of windings is called compound wound DC generator. Compound wound generators have both series field winding and shunt field winding. One winding is placed in series with the armature and the other is placed in parallel with the armature. This type of DC generators may be of two types- short shunt compound wound generator and long shunt compound wound generator.

Short Shunt Compound Wound DC Generator

The generators in which only shunt field winding is in parallel with the armature winding as shown in

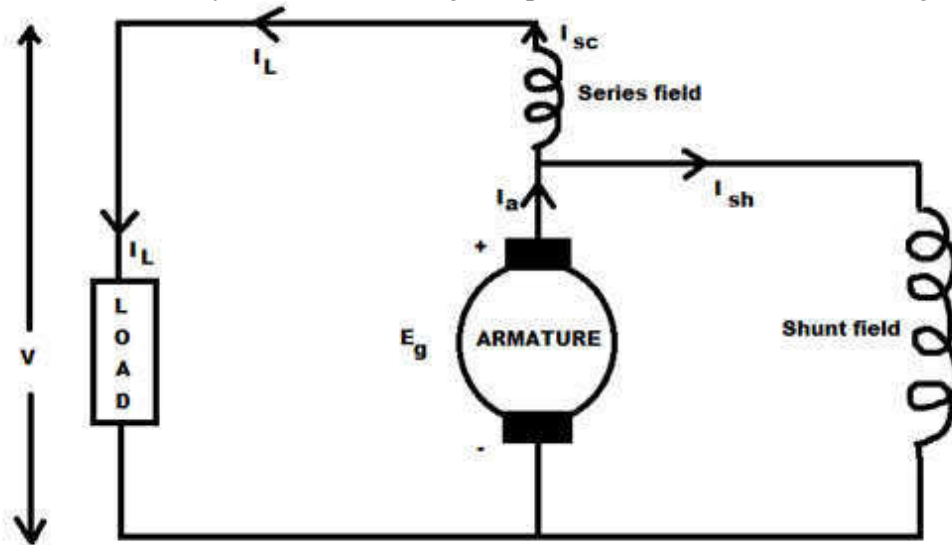

Short Shunt Compound Wound Generator

figure.

Series field current, $I_{sc} = I_L$ Shunt field current, $I_{sh} = (V + I_{sc} R_{sc}) / R_{sh}$ Armature current, $I_a = I_{sh} + I_L$ Voltage across the load, $V = E_g - I_a R_a - I_{sc} R_{sc}$ Power generated, $P_g = E_g \times I_a$ Power delivered to the load, $P_L = V \times I_L$

Long Shunt Compound Wound DC Generator

The generators in which shunt field winding is in parallel with both series field and armature winding as

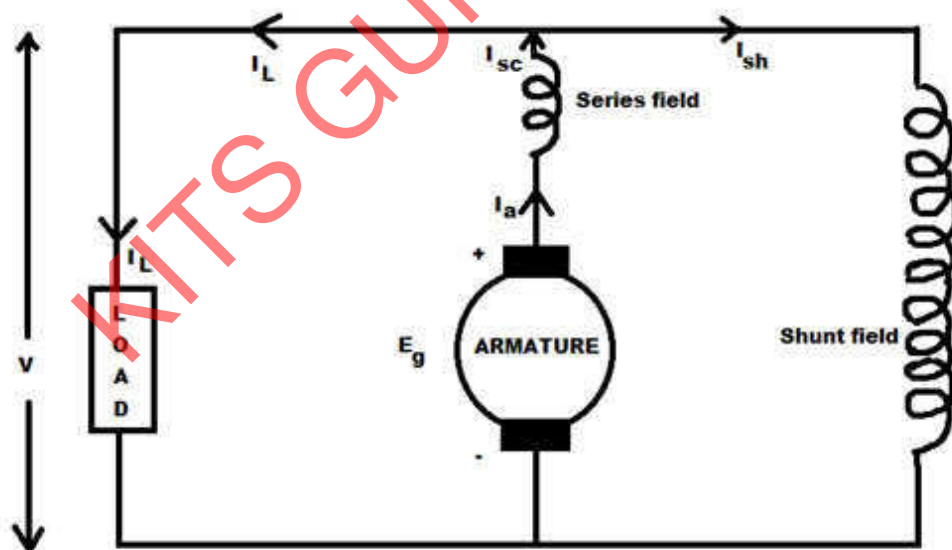

Long Shunt Compound Wound Generator

shown in figure.

Shunt field current, $I_{sh} = V / R_{sh}$ Armature current, $I_a =$ series field current, $I_{sc} = I_L + I_{sh}$ Voltage across the load, $V = E_g - I_a R_a - I_{sc} R_{sc} = E_g - I_a (R_a + R_{sc})$ [$\because I_a = I_{sc}$] Power generated, $P_g = E_g \times I_a$ Power delivered to the load, $P_L = V \times I_L$ In a compound wound generator, the shunt field is stronger than the series field. When the series field assists the shunt field, generator is said to be commutatively compound wound. On the other hand if series field

opposes the shunt field, the generator is said to be differentially compound wound.

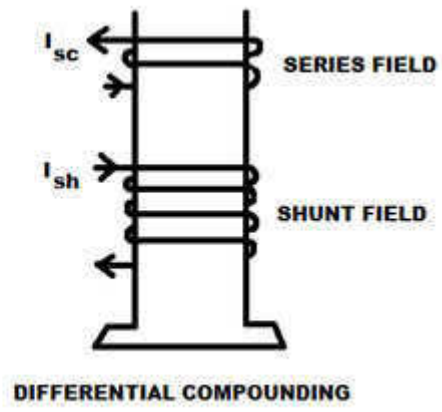
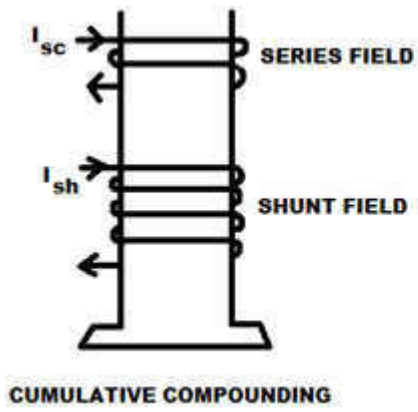

KITS GUNTUR

D.C. GENERATOR CHARACTERISTICS

Introduction

The speed of a d.c. machine operated as a generator is fixed by the prime mover. For general-purpose operation, the prime mover is equipped with a speed governor so that the speed of the generator is practically constant. Under such condition, the generator performance deals primarily with the relation between excitation, terminal voltage and load. These relations can be best exhibited graphically by means of curves known as generator characteristics. These characteristics show at a glance the behaviour of the generator under different load conditions.

3.1 D.C. Generator Characteristics

The following are the three most important characteristics of a d.c. generator:

Open Circuit Characteristic (O.C.C.)

This curve shows the relation between the generated e.m.f. at no-load (E_0) and the field current (I_f) at constant speed. It is also known as magnetic characteristic or no-load saturation curve. Its shape is practically the same for all generators whether separately or self-excited. The data for O.C.C. curve are obtained experimentally by operating the generator at no load and constant speed and recording the change in terminal voltage as the field current is varied.

External characteristic (V/I_L)

This curve shows the relation between the terminal voltage (V) and load current (I_L). The terminal voltage V will be less than E due to voltage drop in the armature circuit. Therefore, this curve will lie below the internal characteristic. This characteristic is very important in determining the suitability of a generator for a given purpose. It can be obtained by making simultaneous measurements of terminal voltage and load current (with voltmeter and ammeter) of a loaded generator.

Internal or Total characteristic (E/I_a)

This curve shows the relation between the generated e.m.f. on load (E) and the armature current (I_a). The e.m.f. E is less than E_0 due to the demagnetizing effect of armature reaction. Therefore, this curve will lie below the open circuit characteristic (O.C.C.). The internal characteristic is of interest chiefly to the designer. It cannot be obtained directly by experiment. It is because a voltmeter cannot read the e.m.f. generated on load due to the voltage drop in armature resistance. The internal characteristic can be obtained from external characteristic if winding resistances are known because armature reaction effect is included in both characteristics.

3.2 Open Circuit Characteristic of a D.C. Generator

The O.C.C. for a d.c. generator is determined as follows. The field winding of the d.c. generator (series or shunt) is disconnected from the machine and is separately excited from an external d.c. source as shown in Fig. (3.1) (ii). The generator is run at fixed speed (i.e., normal speed). The field current (I_f) is increased from zero in steps and the corresponding values of generated e.m.f. (E_0) read off on a voltmeter connected across the armature terminals. On plotting the relation between E_0 and I_f , we get the open circuit characteristic as shown in Fig. (3.1) (i).

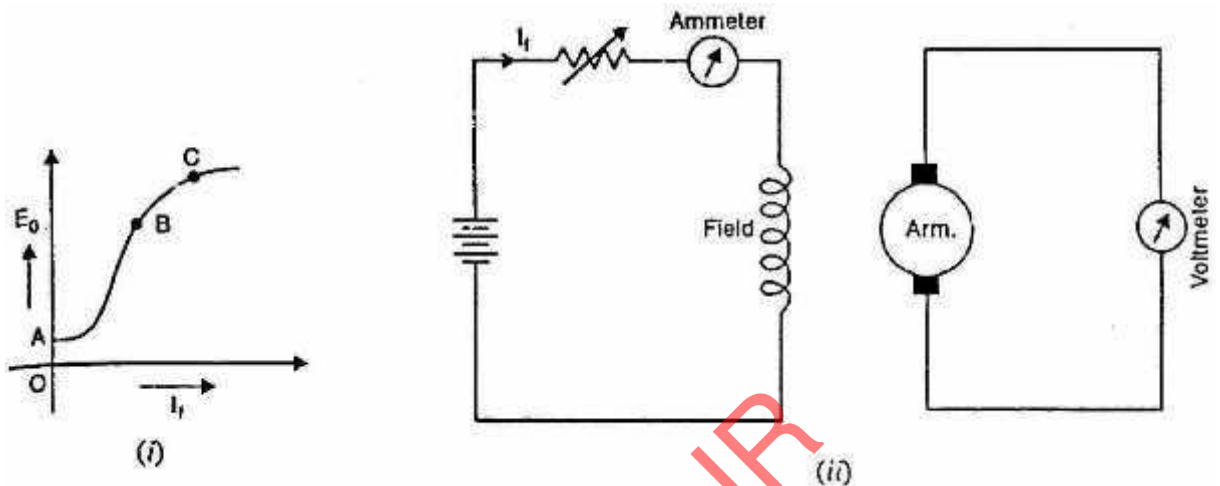

Fig. (3.1)

The following points may be noted from O.C.C.:

4. When the field current is zero, there is some generated e.m.f. OA. This is due to the residual magnetism in the field poles.
5. Over a fairly wide range of field current (upto point B in the curve), the curve is linear. It is because in this range, reluctance of iron is negligible as compared with that of air gap. The air gap reluctance is constant and hence linear relationship.
6. After point B on the curve, the reluctance of iron also comes into picture. It is because at higher flux densities, μ_r for iron decreases and reluctance

of iron is no longer negligible. Consequently, the curve deviates from linear relationship.
 (iv) After point C on the curve, the magnetic saturation of poles begins and E_0 tends to level off.

The reader may note that the O.C.C. of even self-excited generator is obtained by running it as a separately excited generator.

3.3 Characteristics of a Separately Excited D.C. Generator

The obvious disadvantage of a separately excited d.c. generator is that we require an external d.c. source for excitation. But since the output voltage may be controlled more easily and over a wide range (from zero to a maximum), this type of excitation finds many applications.

(i) Open circuit characteristic.

The O.C.C. of a separately excited generator is determined in a manner described in Sec. (3.2). Fig. (3.2) shows the variation of generated e.m.f. on no load with field current for various fixed speeds. Note that if the value of constant speed is increased, the steepness of the curve also increases. When the field current is zero, the residual magnetism in the poles will give rise to the small initial e.m.f. as shown.

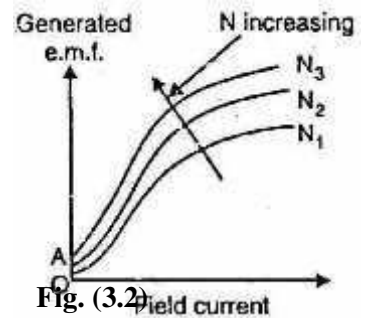

(ii) Internal and External Characteristics

The external characteristic of a separately excited generator is the curve between the terminal voltage (V) and the load current I_L (which is the same as armature current in this case). In order to determine the external characteristic, the circuit set up is as shown in Fig. (3.3) (i). As the load current increases, the terminal voltage falls due to two reasons:

- (a) The armature reaction weakens the main flux so that actual e.m.f. generated E on load is less than that generated (E_0) on no load.
- (b) There is voltage drop across armature resistance ($= I_L R_a = I_a R_a$).

Due to these reasons, the external characteristic is a drooping curve [curve 3 in Fig. 3.3 (ii)]. Note that in the absence of armature reaction and armature drop, the generated e.m.f. would have been E_0 (curve 1).

The internal characteristic can be determined from external characteristic by adding $I_L R_a$ drop to the external characteristic. It is because armature reaction drop is included in the external characteristic. Curve 2 is the internal

characteristic of the generator and should obviously lie above the external characteristic.

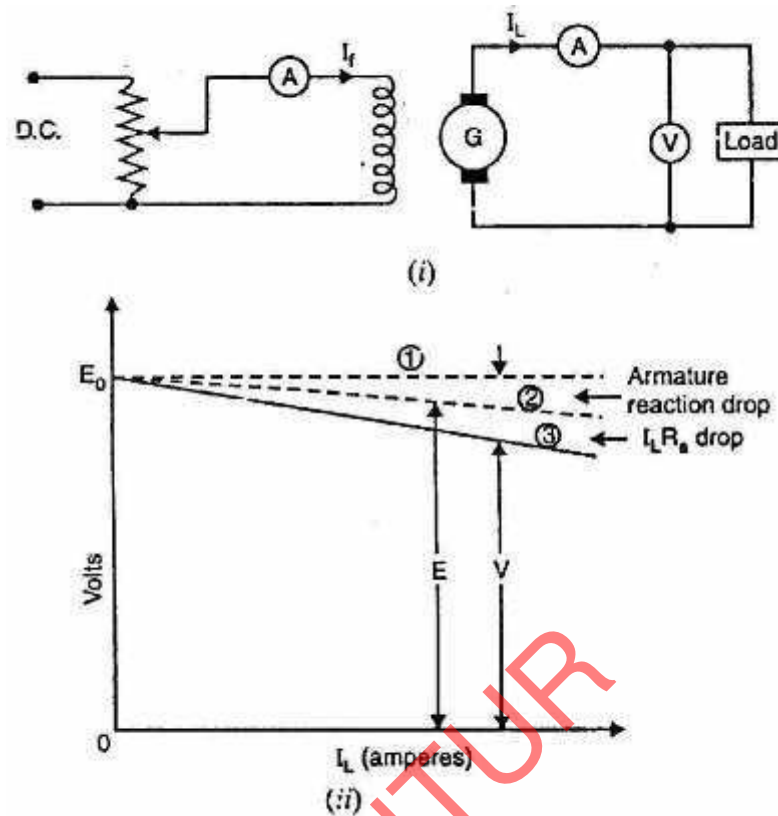

Fig. (3.3)

3.4 Voltage Build-Up in a Self-Excited Generator

Let us see how voltage builds up in a self-excited generator.

(i) Shunt generator

Consider a shunt generator. If the generator is run at a constant speed, some e.m.f. will be generated due to residual magnetism in the main poles. This small e.m.f. circulates a field current which in turn produces additional flux to reinforce the original residual flux (provided field winding connections are correct). This process continues and the generator builds up the normal generated voltage following the O.C.C. shown in Fig. (3.4) (i).

The field resistance R_f can be represented by a straight line passing through the origin as shown in Fig. (3.4) (ii). The two curves can be shown on the same diagram as they have the same ordinate [See Fig. 3.4 (iii)].

Since the field circuit is inductive, there is a delay in the increase in current upon closing the field circuit switch. The rate at which the current increases depends

upon the voltage available for increasing it. Suppose at any instant, the field current is i ($= OA$) and is increasing at the rate di/dt . Then,

$$E_0 - i R_f = L \frac{di}{dt}$$

where R_f = total field circuit resistance L = inductance of field circuit

At the considered instant, the total e.m.f. available is AC [See Fig. 3.4 (iii)]. An amount AB of the c.m.f. AC is absorbed by the voltage drop iR_f and the remainder part BC is available to overcome $L di/dt$. Since this surplus voltage is available, it is possible for the field current to increase above the value OA .

However, at point D , the available voltage is OM and is all absorbed by $i R_f$ drop. Consequently, the field current cannot increase further and the generator build up stops.

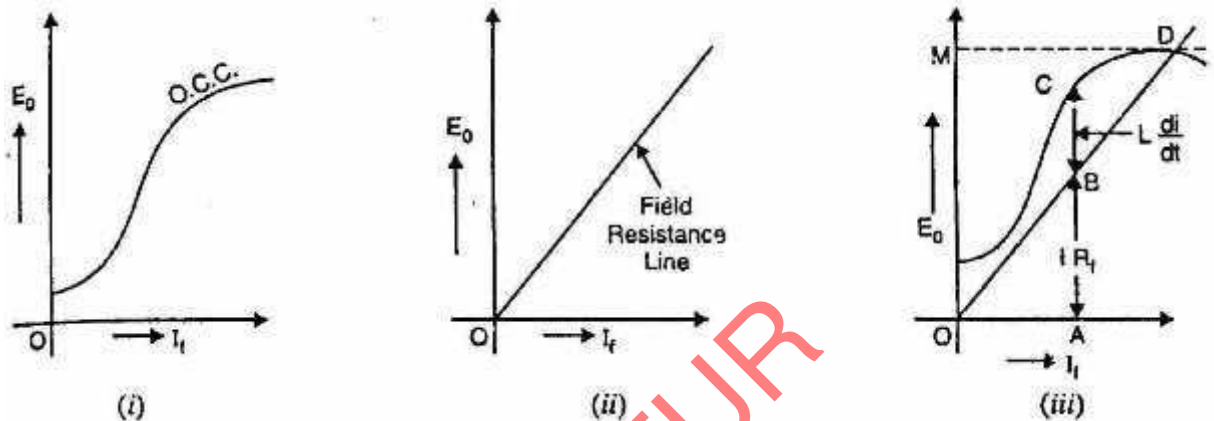

Fig. (3.4)

We arrive at a very important conclusion that the voltage build up of the generator is given by the point of intersection of O.C.C. and field resistance line. Thus in Fig. (3.4) (iii), D is point of intersection of the two curves. Hence the generator will build up a voltage OM .

(ii) Series generator

During initial operation, with no current yet flowing, a residual voltage will be generated exactly as in the case of a shunt generator. The residual voltage will cause a current to flow through the whole series circuit when the circuit is closed. There will then be voltage build up to an equilibrium point exactly analogous to the build up of a shunt generator. The voltage build up graph will be similar to that of shunt generator except that now load current (instead of field current for shunt generator) will be taken along x-axis.

(iii) Compound generator

When a compound generator has its series field flux aiding its shunt field flux, the machine is said to be cumulative compound. When the series field is connected in reverse so that its field flux opposes the shunt field flux, the generator is then differential compound.

The easiest way to build up voltage in a compound generator is to start under no load conditions. At no load, only the shunt field is effective. When no-load voltage build up is achieved, the generator is loaded. If under load, the voltage rises, the series field connection is cumulative. If the voltage drops significantly, the connection is differential compound.

3.5 Critical Field Resistance for a Shunt Generator

We have seen above that voltage build up in a shunt generator depends upon field circuit resistance. If the field circuit resistance is R_1 (line OA), then generator will build up a voltage OM as shown in Fig. (3.5). If the field circuit resistance is increased

to R_2 (line OB), the generator will build up a voltage OL, slightly less than OM. As the field circuit resistance is increased, the slope of resistance line also increases. When the field resistance line becomes tangent (line OC) to

O.C.C., the generator would just excite. If the field circuit resistance is increased beyond this point (say line OD), the generator will fail to excite. The field circuit resistance represented by line OC (tangent to O.C.C.) is called critical field resistance R_c for the shunt generator. It may be defined as under:

The maximum field circuit resistance (for a given speed) with which the shunt generator would just excite is known as its critical field resistance.

It should be noted that shunt generator will build up voltage only if field circuit resistance is less than critical field resistance.

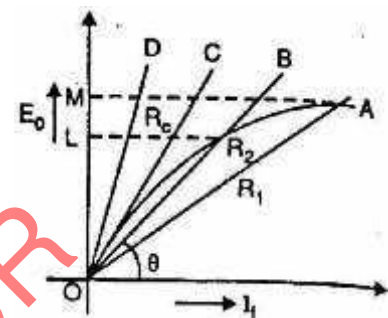

Fig. (3.5)

3.6 Critical Resistance for a Series Generator

Fig. (3.6) shows the voltage build up in a series generator. Here R_1 , R_2 etc. represent the total circuit resistance (load resistance and field winding resistance). If the total circuit resistance is R_1 , then series generator will build up a voltage OL. The

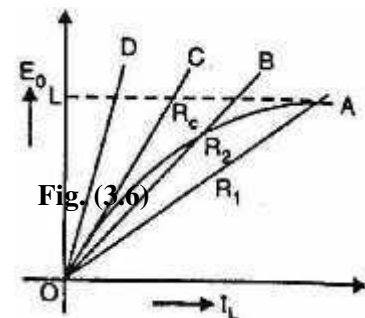

Fig. (3.6)

line OC is tangent to O.C.C. and represents the critical resistance R_C for a series generator. If the total resistance of the circuit is more than R_C (say line OD), the generator will fail to build up voltage. Note that Fig. (3.6) is similar to Fig. (3.5) with the following differences:

(i) In Fig. (3.5), R_1, R_2 etc. represent the total field circuit resistance. However, R_1, R_2 etc. in Fig. (3.6) represent the total circuit resistance (load resistance and series field winding resistance etc.).

(ii) In Fig (3.5), field current alone is represented along X-axis. However, in Fig. (3.6) load current I_L is represented along Y-axis. Note that in a series generator, field current = load current I_L .

3.7 Characteristics of Series Generator

Fig. (3.7) (i) shows the connections of a series wound generator. Since there is only one current (that which flows through the whole machine), the load current is the same as the exciting current.

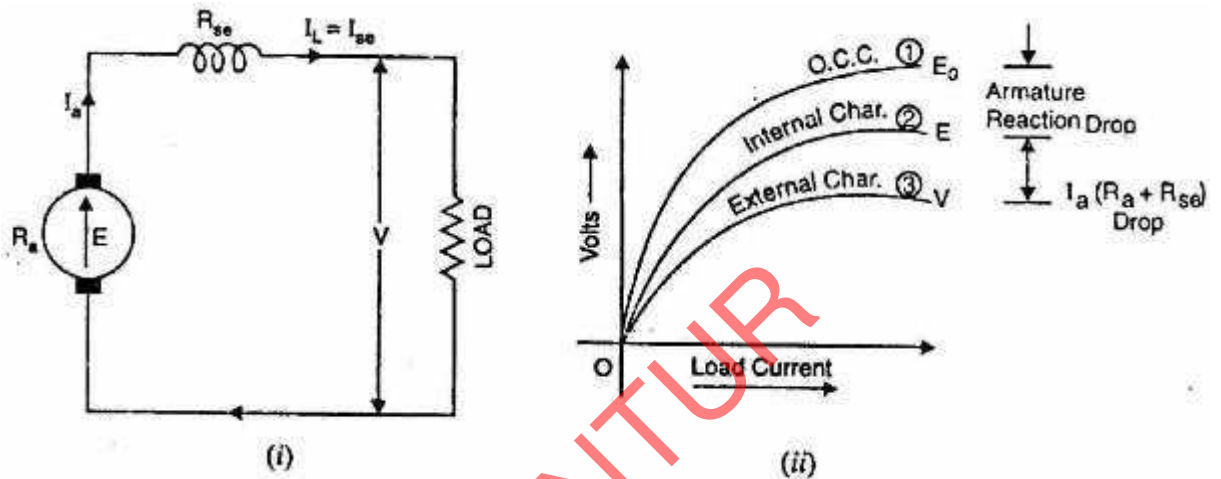

Fig. (3.7)

(i) O.C.C.

Curve 1 shows the open circuit characteristic (O.C.C.) of a series generator. It can be obtained experimentally by disconnecting the field winding from the machine and exciting it from a separate d.c. source as discussed in Sec. (3.2).

(ii) Internal characteristic

Curve 2 shows the total or internal characteristic of a series generator. It gives the relation between the generated e.m.f. E on load and armature current. Due to armature reaction, the flux in the machine will be less than the flux at no load.

Hence, e.m.f. E generated under load conditions will be less than the e.m.f. E_0 generated under no load conditions. Consequently, internal characteristic curve

lies below the O.C.C. curve; the difference between them representing the effect of armature reaction [See Fig. 3.7 (ii)].

(iii) External characteristic

Curve 3 shows the external characteristic of a series generator. It gives the relation between terminal voltage and load current I_L .

$$V = E - I_a(R_a + R_{se})$$

Therefore, external characteristic curve will lie below internal characteristic curve by an amount equal to ohmic drop [i.e., $I_a(R_a + R_{se})$] in the machine as shown in Fig. (3.7) (ii).

The internal and external characteristics of a d.c. series generator can be plotted from one another as shown in Fig. (3.8). Suppose we are given the internal characteristic of the generator. Let the line OC represent the resistance of the whole machine i.e. $R_a + R_{se}$. If the load current is OB, drop in the machine is AB i.e.

$$AB = \text{Ohmic drop in the machine} = OB(R_a + R_{se})$$

Now raise a perpendicular from point B and mark a point b on ab = AB. Then point b will lie on the external characteristic of Following similar procedure, other points of external be located. It is easy to see that we can also plot internal the external characteristic.

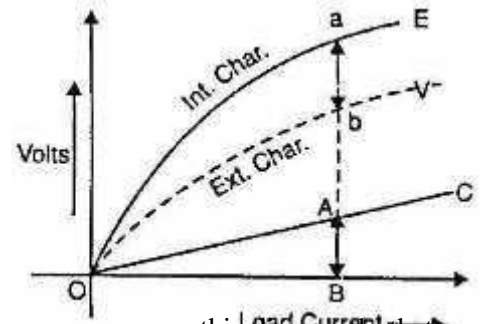

this line such that the generator characteristic can be plotted from

3.8 Characteristics of a Shunt Generator

Fig (3.9) (i) shows the connections of a shunt wound generator. current I_a splits up into two parts; a small fraction I_{sh} flowing through shunt field winding while the major part I_L goes to the external load.

(i) O.C.C.

The O.C.C. of a shunt generator is similar in shape to that of a series generator as shown in Fig. (3.9) (ii). The line OA represents the shunt field circuit resistance. When the generator is run at normal speed, it will build up a voltage OM. At no-load, the terminal voltage of the generator will be constant (= OM) represented by the horizontal dotted line MC.

Fig. (3.8)

The armature through shunt field

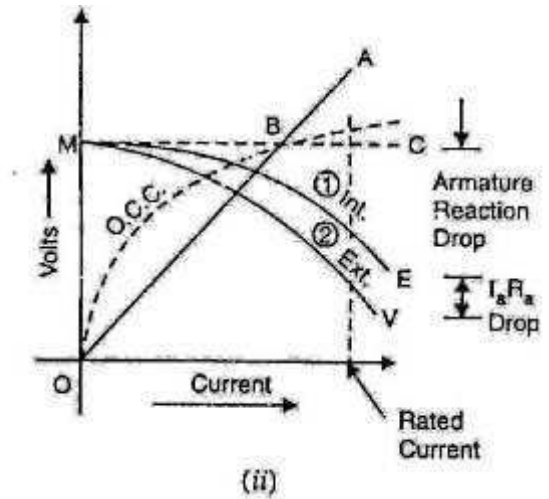
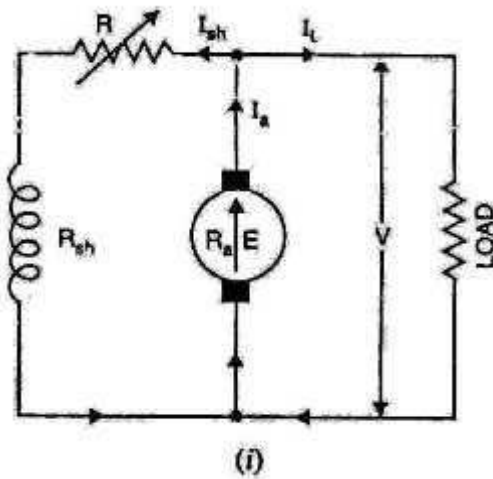

Fig. (3.9)

(ii) Internal characteristic

When the generator is loaded, flux per pole is reduced due to armature reaction. Therefore, e.m.f. E generated on load is less than the e.m.f. generated at no load. As a result, the internal characteristic (E/I_a) drops down slightly as shown in Fig. (3.9) (ii).

(iii) External characteristic

Curve 2 shows the external characteristic of a shunt generator. It gives the relation between terminal voltage V and load current I_L .

$$V = E - I_a R_a - I_L R_a - I_{sh} R_a$$

Therefore, external characteristic curve will lie below the internal characteristic curve by an amount equal to drop in the armature circuit [i.e., $(I_L + I_{sh})R_a$] as shown in Fig. (3.9) (ii).

Note. It may be seen from the external characteristic that change in terminal voltage from no-load to full load is small. The terminal voltage can always be maintained constant by adjusting the field rheostat R automatically

3.9 Critical External Resistance for Shunt Generator

If the load resistance across the terminals of a shunt generator is decreased, then load current increase? However, there is a limit to the increase in load current with the decrease of load resistance. Any decrease of load resistance beyond this point, instead of increasing the current, ultimately results in

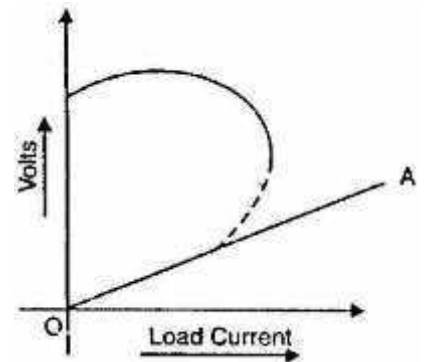

Fig. (3.10)

reduced current. Consequently, the external characteristic turns back (dotted curve) as shown in Fig. (3.10). The tangent OA to the curve represents the minimum external resistance required to excite the shunt generator on load and is called critical external resistance. If the resistance of the external circuit is less than the critical external resistance (represented by tangent OA in Fig. 3.10), the machine will refuse to excite or will de-excite if already running. This means that external resistance is so low as virtually to short circuit the machine and so doing away with its excitation.

Note. There are two critical resistances for a shunt generator viz., (i) critical field resistance (ii) critical external resistance. For the shunt generator to build up voltage, the former should not be exceeded and the latter must not be gone below.

3.10 How to Draw O.C.C. at Different Speeds?

If we are given O.C.C. of a generator at a constant speed N_1 , then we can easily draw the O.C.C. at any other constant speed N_2 . Fig (3.11) illustrates the procedure. Here we are given O.C.C. at a constant speed N_1 . It is desired to find the O.C.C. at constant speed N_2 (it is assumed that $n_1 < N_2$). For constant excitation, $E \propto N$.

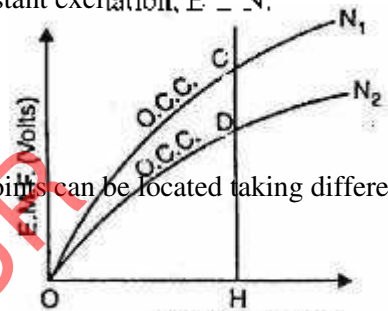

This locates the point D on the new O.C.C. at N_2 . Similarly, other points can be located taking different values of I_f . The locus of these points will be the O.C.C. at N_2 .

3.11 Critical Speed (N_c)

The critical speed of a shunt generator is the minimum speed below which it fails to excite. Clearly, it is the speed for which the given shunt field resistance represents the critical resistance. In Fig. (3.12), curve 2 corresponds to critical speed because the shunt field resistance (R_{sh}) line is tangential to it. If the

generator runs at full speed N , the new O.C.C. moves upward and the R'_{sh} line represents critical resistance for this speed.

□ Speed □ Critical resistance

In order to find critical speed, take any convenient point C on excitation axis and erect a perpendicular so as to cut R_{sh} and R'_{sh} lines at points B and A respectively. Then,

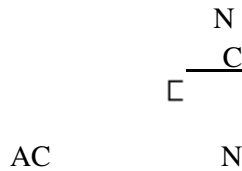

or $\frac{N}{c} = \frac{AC}{N}$

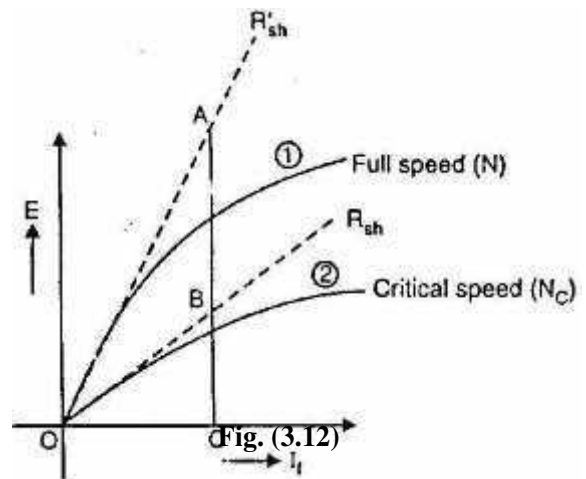

3.12 Conditions for Voltage Build-Up of a Shunt Generator

The necessary conditions for voltage build-up in a shunt generator are:

- (v) There must be some residual magnetism in generator poles.
- (vi) The connections of the field winding should be such that the field current strengthens the residual magnetism.
- (vii) The resistance of the field circuit should be less than the critical resistance. In other words, the speed of the generator should be higher than the critical speed.

3.13 Compound Generator Characteristics

In a compound generator, both series and shunt excitation are combined as shown in Fig. (3.13). The shunt winding can be connected either across the armature only (short-shunt connection S) or across armature plus series field (long-shunt connection G). The compound generator can be cumulatively compounded or differentially compounded generator. The latter is rarely used in practice. Therefore, we shall discuss the characteristics of cumulatively-compounded generator. It may be noted that external characteristics of long and short shunt compound generators are almost identical.

External characteristic

Fig. (3.14) shows the external characteristics of a cumulatively compounded generator. The series excitation aids the shunt excitation. The degree of

compounding depends upon the increase in series excitation with the increase in load current.

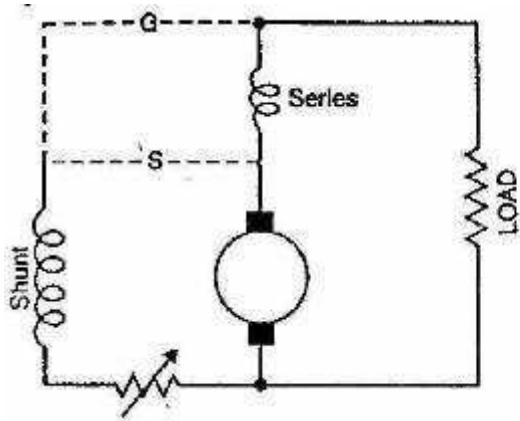

Fig. (3.13)

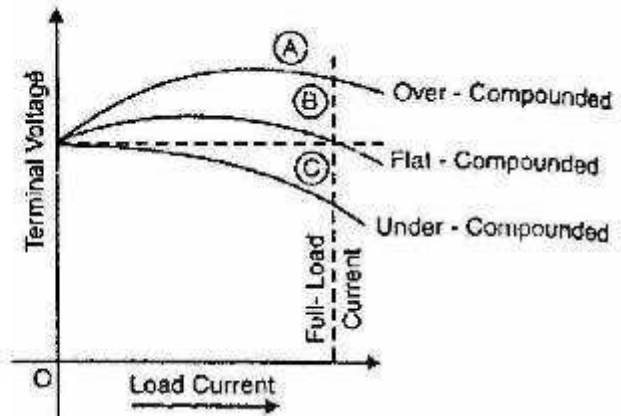

Fig. (3.14)

(i) If series winding turns are so adjusted that with the increase in load current the terminal voltage increases, it is called over-compounded generator. In such a case, as the load current increases, the series field m.m.f. increases and tends to increase the flux and hence the generated voltage. The increase in generated voltage is greater than the $I_a R_a$ drop so that instead of decreasing, the terminal voltage increases as shown by curve A in Fig. (3.14).

(c) If series winding turns are so adjusted that with the increase in load current, the terminal voltage substantially remains constant, it is called flat-compounded generator. The series winding of such a machine has lesser number of turns than the one in over-compounded machine and, therefore, does not increase the flux as much for a given load current. Consequently, the full-load voltage is nearly equal to the no-load voltage as indicated by curve B in Fig (3.14).

(d) If series field winding has lesser number of turns than for a flat-compounded machine, the terminal voltage falls with increase in load current as indicated by curve C in Fig. (3.14). Such a machine is called under-compounded generator.

3.14 Voltage Regulation

The change in terminal voltage of a generator between full and no load (at constant speed) is called the voltage regulation, usually expressed as a percentage of the voltage at full-load.

$$\% \text{ Voltage regulation} = \frac{V_{NL} - V_{FL}}{V_{FL}} \times 100$$

where V_{NL} = Terminal voltage of generator at no load

V_{FL} = Terminal voltage of generator at full load

Note that voltage regulation of a generator is determined with field circuit and speed held constant. If the voltage regulation of a generator is 10%, it means that terminal voltage increases 10% as the load is changed from full load to no load.

3.15 Parallel Operation of D.C. Generators

In a d.c. power plant, power is usually supplied from several generators of small ratings connected in parallel instead of from one large generator. This is due to the following reasons:

(i) Continuity of service

If a single large generator is used in the power plant, then in case of its breakdown, the whole plant will be shut down. However, if power is supplied from a number of small units operating in parallel, then in case of failure of one unit, the continuity of supply can be maintained by other healthy units.

(ii) Efficiency

Generators run most efficiently when loaded to their rated capacity. Electric power costs less per kWh when the generator producing it is efficiently loaded. Therefore, when load demand on power plant decreases, one or more generators can be shut down and the remaining units can be efficiently loaded.

(iii) Maintenance and repair

Generators generally require routine-maintenance and repair. Therefore, if generators are operated in parallel, the routine or emergency operations can be performed by isolating the affected generator while load is being supplied by other units. This leads to both safety and economy.

(iv) Increasing plant capacity

In the modern world of increasing population, the use of electricity is continuously increasing. When added capacity is required, the new unit can be simply paralleled with the old units.

(v) Non-availability of single large unit

In many situations, a single unit of desired large capacity may not be available. In that case a number of smaller units can be operated in parallel to meet the load requirement. Generally a single large unit is more expensive.

3.16 Connecting Shunt Generators in Parallel

The generators in a power plant are connected in parallel through bus-bars. The bus-bars are heavy thick copper bars and they act as +ve and -ve terminals. The positive terminals of the generators are connected to the +ve side of bus-bars and negative terminals to the negative side of bus-bars.

Fig. (3.15) shows shunt generator 1 connected to the bus-bars and supplying load. When the load on the power plant increases beyond the capacity of this generator, the second shunt generator 2 is connected in parallel with the first to meet the increased load demand. The procedure for paralleling generator 2 with generator 1 is as under:

(i) The prime mover of generator 2 is brought up to the rated speed. Now switch S_4 in the field circuit of the generator 2 is closed.

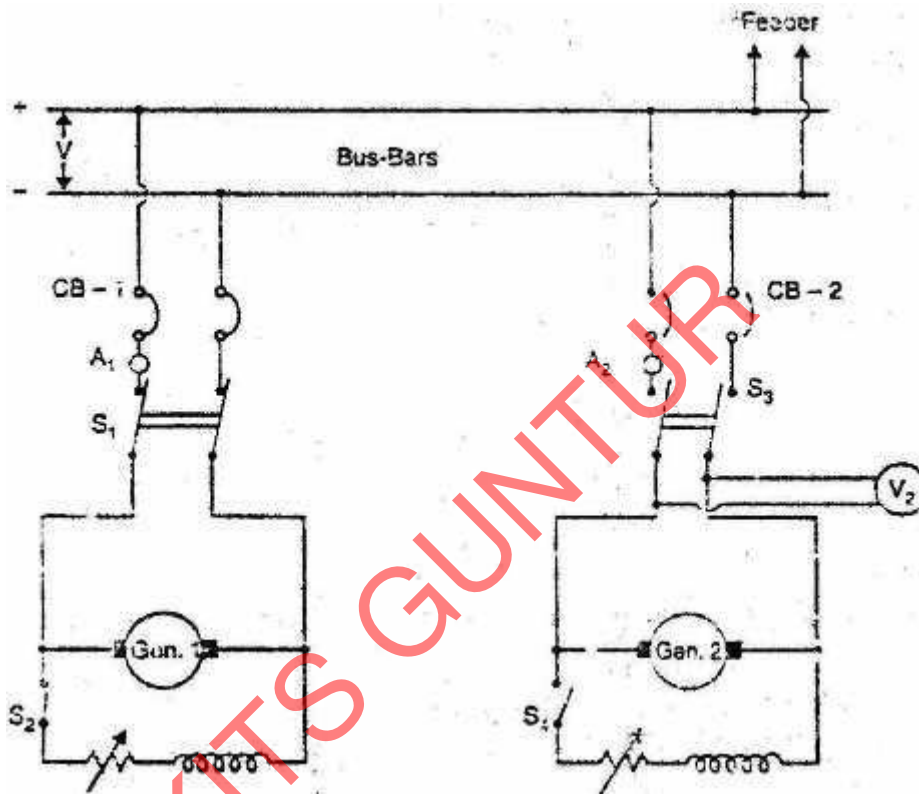

Fig. (3.15)

(ii) Next circuit breaker CB-2 is closed and the excitation of generator 2 is adjusted till it generates voltage equal to the bus-bars voltage. This is indicated by voltmeter V_2 .

(v) Now the generator 2 is ready to be paralleled with generator 1. The main switch S_3 , is closed, thus putting generator 2 in parallel with generator 1. Note that generator 2 is not supplying any load because its generated e.m.f. is equal to bus-bars voltage. The generator is said to be "floating" (i.e., not supplying any load) on the bus-bars.

(iv) If generator 2 is to deliver any current, then its generated voltage E should be greater than the bus-bars voltage V . In that case, current supplied by it is $I = \frac{E - V}{R_a}$ where R_a is the resistance of the armature circuit. By increasing the field current (and hence induced e.m.f. E), the generator 2 can be made to supply proper amount of load.

(v) The load may be shifted from one shunt generator to another merely by adjusting the field excitation. Thus if generator 1 is to be shut down, the whole load can be shifted onto generator 2 provided it has the capacity to supply that load. In that case, reduce the current supplied by generator 1 to zero (This will be indicated by ammeter A_1) open C.B.-1 and then open the main switch S_1 .

3.17 Load Sharing

The load sharing between shunt generators in parallel can be easily regulated because of their drooping characteristics. The load may be shifted from one generator to another merely by adjusting the field excitation. Let us discuss the load sharing of two generators which have unequal no-load voltages.

Let E_1, E_2 = no-load voltages of the two generators
 R_1, R_2 = their armature resistances

V = common terminal voltage (Bus-bars voltage)

Then
$$I_1 = \frac{E_1 - V}{R_1} \text{ and } I_2 = \frac{E_2 - V}{R_2}$$

Thus current output of the generators depends upon the values of E_1 and E_2 . These values may be changed by field rheostats. The common terminal voltage (or bus-bars voltage) will depend upon (i) the e.m.f.s of individual generators and (ii) the total load current supplied. It is generally desired to keep the bus-bars voltage constant. This can be achieved by adjusting the field excitations of the generators operating in parallel.

3.18 Compound Generators in Parallel

Under-compounded generators also operate satisfactorily in parallel but over-compounded generators will not operate satisfactorily unless their series fields are paralleled. This is achieved by connecting two negative brushes together as shown in Fig. (3.16) (i). The conductor used to connect these brushes is generally called equalizer bar. Suppose that an attempt is made to operate the two generators in Fig. (3.16) (ii) in parallel without an equalizer bar. If, for any reason, the current supplied by generator 1 increases slightly, the current in its series field will increase and raise the generated voltage. This will cause generator 1 to take more load. Since total load supplied to the system is constant, the current in generator 2 must decrease and as a result its series field is

weakened. Since this effect is cumulative, the generator 1 will take the entire load and drive generator 2 as a motor. Under such conditions, the current in the two machines will be in the direction shown in Fig. (3.16) (ii). After machine 2 changes from a generator to a motor, the current in the shunt field will remain in the same direction, but the current in the armature and series field will reverse. Thus the magnetizing action, of the series field opposes that of the shunt field. As the current taken by the machine 2 increases, the demagnetizing action of series field becomes greater and the resultant field becomes weaker. The resultant field will finally become zero and at that time machine 2 will short-circuit machine 1, opening the breaker of either or both machines.

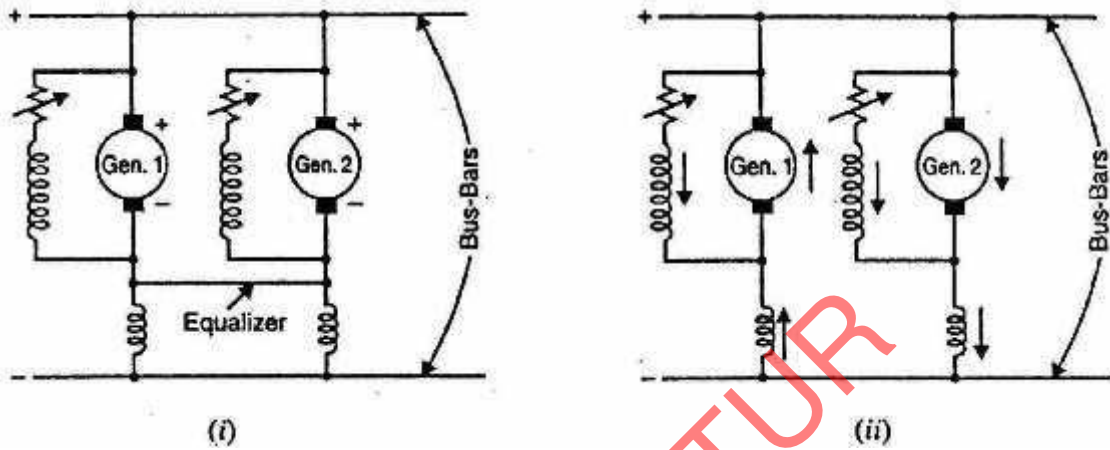

Fig. (3.16)

When the equalizer bar is used, a stabilizing action exists and neither machine tends to take all the load. To consider this, suppose that current delivered by generator 1 increases [See Fig. 3.16 (i)]. The increased current will not only pass through the series field of generator 1 but also through the equalizer bar and series field of generator 2. Therefore, the voltage of both the machines increases and the generator 2 will take a part of the load.

UNIT IV DC MOTOR

A dc motor is similar in construction to a dc generator. As a matter of fact a dc generator will run as a motor when its field & armature windings are connected to a source of direct current.

The basic construction is same whether it is generator or a motor.

Working principle:

The principle of operation of a dc motor can be stated as when a current carrying conductor is placed in a magnetic field; it experiences a mechanical force. In a practical dc motor, the field winding produces the required magnetic field while armature conductors play the role of current carrying conductor and hence the armature conductors experience a force.

As conductors are placed in the slots which are on the periphery, the individual force experienced by the conductive acts as a twisting or turning force on the armature which is called a torque.

The torque is the product of force and the radius at which this force acts, so overall armature experiences a torque and starts rotating.

Consider a single conductor placed in a magnetic field, the magnetic field is produced by a permanent magnet but in practical dc motor it is produced by the field winding when it carries a current.

Now this conductor is excited by a separate supply so that it carries a current in a particular direction.

Consider that it carries a current away from an current. Any current carrying conductor produces its own magnetic field around it, hence this conductor also produces its own flux, around. The direction of this flux can be determined by right hand thumb rule. For direction of current considered the direction of flux around a conductor is clock-wise. Now, there are two fluxes present

5. Flux produced by permanent magnet called main flux
6. Flux produced by the current carrying conductor

From the figure shown below, it is clear that on one side of the conductor, both the fluxes are in the same direction in this case, on the left of the conductor there gathering of the flux lines as two fluxes help each other. As to against this, on the right of the conductor, the two fluxes are in opposite direction and hence try to cancel each other. Due to this, the density of the flux lines in this area gets weakened.

So on the left, there exists high flux density area while on the right of the conductor then exists low flux density area as shown.

The flux distribution around the conductor acts like a stretched ribbed band under tension. This exerts a mechanical force on the conductor which acts from high flux density area towards low flux density area, i.e. from left to right from the case considered as shown above.

In the practical dc motor, the permanent magnet is replaced by the field winding which produces the required flux winding which produces the required flux called main flux and all the armature conductors, would on the periphery of the armature gram, get subjected to the mechanical force.

Due to this, overall armature experiences a twisting force called torque and armature of the motor starts rotating.

Direction of rotation of motor

The magnitude of the force experienced by the conductor in a motor is given by $F = BIL$ newtons.

The direction of the main field can be revoked by changing the direction of current passing through the field winding, which is possible by interchanging the polarities of supply which is given to the field winding.

The direction of current through armature can be reversed by changing supply polarities of dc supplying current to the armature.

If directions of both the currents are changed then the direction of rotation of the motor remains undamaged.

In a dc motor both the field and armature is connected to a source of direct current. The current through the armature winding establish its own magnetic flux the interaction both the main field and the armature current produces the torque, there by sensing the motor to rotate, once the motor starts rotating, already existing magnetic flux there will be an induced emf in the armature conductors due to generator action. This emf acts in a direction opposite to supplied voltage. Therefore it is called Back emf.

Significance of Back emf

In the generating action, when a conductor cuts the lines of flux, emf gets induced in the conductor in a motor, after a motoring action, armature starts rotating and armature conductors cut the main flux. After a motoring action, there exists a generating action there is induced emf in the rotating armature conductors according to Faraday's law of electromagnetic induction. This induced emf in the armature always acts in the opposite direction of the supply voltage. This is according to Lenz's law which states that the direction of the induced emf is always so as to oppose the cause producing it.

In a dc motor, electrical input i.e., the supply voltage is the cause and hence this induced emf opposes the supply voltage.

The emf tries to set up a current throughout the armature which is in the opposite direction to that which supply voltage is forcing through the conductor so, as this emf always opposes the supply voltage, it is called back emf and denoted as E_b .

Through it is denoted as E_b , basically it gets generated by the generating action which we have seen earlier So, E_b

$$60 \text{ A}$$

Voltage equation of a Motor

The voltage v applied across the motor armature has to (1) overcome the back emf E_b and

3. supply the armature ohmic drop $I_a R_a$

$$v = E_b + I_a R_a$$

This is known as voltage equation of a motor

Multiplying both sides by I_a , we get

$$V I_a = E_b I_a + I_a^2 R_a$$

$V I_a$ = electrical input to the armature

$E_b I_a$ = electrical equivalent of mechanical Power developed in the armature

$I_a^2 R_a =$ un loss in the armature

Hence, out of the armature input, some is wasted in $I^2 R$ loss and the rest is converted into mechanical power within the armature.

Motor efficiency is given by the ratio of power developed by the armature to its input i.e. $E_b I_a / v I_a = E_b / v$.

Higher the value of E_b as compared to v , higher the motor efficiency.

Conduction for maximum powers

The gross mechanical developed by a motor = $p_m = v I_a - I_a^2 R_a$

$$\frac{dP_m}{dI_a} = v - 2I_a R_a \quad I_a R_a = v/2$$

$$\text{As } v = E_b + I_a R_a \quad \text{and } I_a R_a = v/2 \quad E_b = v/2$$

Thus gross mechanical power developed by a motor is maximum when back emf is equal to half the applied voltage. This condition is however not realized in practice, because in that case current will be much beyond the normal current of the motor.

Moreover, half the input would be wasted in the form of heat and taking other losses into consideration the motor efficiency will be well below 50 %.

1. A 220v – dc machine has an armature resistance of 0.5 Ω . If the full road armature current is 20A, find the induced emf when the machine acts (1) generator (2) motor.

The dc motor is assumed to be shunt connected in each case, shunt current is considered negligible because its value is not given.

(a) As generator $E_g = v + I_a R_a = 220 + 0.5 \times 20 = 230 \text{ v}$

(b) As motor $E_b = v - I_a R_a = 220 - 0.5 \times 20 = 210 \text{ v}$

8) A 440 v. shunt motor has armature resistance of 0.8 Ω and field resistance of 200 Ω . Determine the back emf when giving an output of 7.46 kw at 85% efficiency.

$$\text{Motor input power} = \frac{7.46 \times 10^3}{0.85} = 8765 \text{ w}$$

$$\text{Motor input current} = \frac{8765}{440} = 19.92 \text{ A}$$

3. A 25kw, 250 v dc shunt generator has armature and field resistance of 0.06 Ω and 100 Ω respectively. Determine the total armature power developed when working (1) as generator delivering 25 kw output and (2) as a motor taking 25 kw input.

Voltage equation of dc motor

For a generator, generated emf has to supply armature resistance drop and remaining part is available across the load as a terminal voltage. But in case of dc motor, supply voltage v has to overcome back

emf E_b which is opposing v and also various drops are armature resistance drop $I_a R_a$, brush drop etc. In fact the electrical work done in overcoming the back emf gets converted into the mechanical energy, developed in the armature.

Hence, the voltage equation of a dc motor is

$$V = E_b + I_a R_a + \text{brush drops}$$

$$\text{Or } v = E_b + I_a R_a \quad \text{neglecting brush drops}$$

The back emf is always less than supply voltage ($E_b < v$) but R_a is very small hence under normal running conditions, the different between back emf and supply voltage is very small. The net voltage across the armature is the difference between the supply voltage and back emf which decalcs the armature current. Hence from the voltage equation we can write $I_a = v - E_b / R_a$.

3. A 220 v dc motor has an armature resistance of 0.75Ω it is drawing an armature current of 30 A, during a certain load, calculate the induced emf in the motor under this condition.

$$V = 200 \text{ v}, I_a = 30 \text{ A}, R_a = 0.75 \Omega$$

$$\text{For a motor, } v = E_b + I_a R_a$$

$$E_b = 197.5 \text{ v}$$

This is the induced mef called back emf in a motor.

5. A 4-pole dc motor has lap connected armature winding. The number of armature conductors is 250. When connected to 230 v dc supply it draws an armature current $I_a = 40 \text{ A}$ calculate the back emf and the speed with which motor is running. Assume armature is 0.6Ω

$$P = 4 \text{ A} = P = 4 \text{ as lap connected}$$

$$I_a = 40 \text{ A}$$

$$\Phi = 30 \text{ m wb} = 30 \text{ Hc}^{-3} \text{ V} = 230 \text{ v}, z = 250$$

$$\text{From voltage equation } V = E_b + I_a R_a$$

$$230 = E_b + 40 \times 0.6$$

$$E_b = \frac{P \Phi z}{60 A}$$

$$206 = (30 \times 10^{-3} \times 4 \times N \times 250) / (60 \times 4)$$

$$N = 1648 \text{ rpm.}$$

Torque: The turning or twisting movement of a body is called

Torque. (Or)

It is defined as the product of force and perpendicular distance $\tau = F \cdot R$

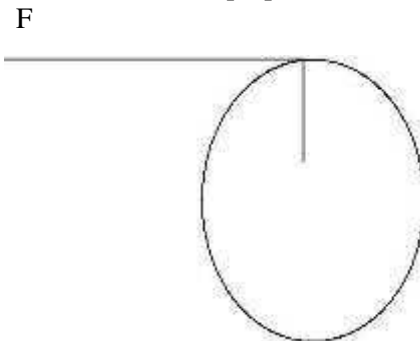

In case of DC motor torque is produced by the armature and shaft called as armature torque (T_a) and shaft torque (T_{sh}).

Let, N be the speed of the armature in

RPM R be the radius of the armature

Power = Work Done / Time

Work Done = Force X Distance

The distance travelled in rotating the armature for one time = $2\pi R$

If N rotations are made in 60 sec

Then time taken for one rotation is = $60/N$

So, Power = $(F * 2\pi R) / (60/N)$

$$P = \frac{(F * R)(2\pi N)}{60}$$

Here $P = E_b I_a$

But

$E_b = \frac{\phi Z N P}{60 A}$

$(\frac{\phi Z N P}{60 A}) I_a =$

$\frac{P}{A}$

$$\frac{P}{A} = \frac{T_a (2\pi N)}{60}$$

Similarly, Shaft torque $T_{sh} = \frac{\text{output}}{\omega}$

$$T_{sh} = \frac{\text{output}}{(2\pi N)/60}$$

$$T_{sh} = 9.55 (\text{output}) / N$$

TESTING OF DC MACHINES

5.1 Introduction

In the previous sections we have learnt about the principle of operation of d.c. generators and motors, (starting and speed control of d.c motor). Motors convert *electrical* power (input power) into *mechanical* power (output power) while generators convert *mechanical* power (input power) into *electrical* power (output power). Whole of the input power can not be converted into the output power in a practical machine due to various losses that take place within the machine. Efficiency η being the ratio of output power to input power, is always less than 1 (or 100 %). Designer of course will try to make η as large as possible. Order of efficiency of rotating d.c machine is about 80 % to 85 %. It is therefore important to identify the losses which make efficiency poor.

In this lesson we shall first identify the losses and then try to estimate them to get an idea of efficiency of a given d.c machine.

5.2 Major losses

Take the case of a loaded d.c motor. There will be copper losses ($I_a^2 r_a$ and $I_f^2 R_f = VI_f$) in armature and field circuit. The armature copper loss is variable and depends upon degree of loading of the machine. For a shunt machine, the field copper loss will be constant if field resistance is not varied. Recall that rotor body is made of iron with slots in which armature conductors are placed. Therefore when armature rotates in presence of field produced by stator field coil, eddy current and hysteresis losses are bound to occur on the rotor body made of iron. The sum of eddy current and hysteresis losses is called the *core* loss or *iron* loss. To reduce *core* loss, circular varnished and slotted laminations or *stamping* are used to fabricate the armature. The value of the core loss will depend on the strength of the field and the armature speed. Apart from these there will be power loss due to *friction* occurring at the bearing & shaft and air friction (windage loss) due to rotation of the armature. To summarise following major losses occur in a d.c machine.

7. Field copper loss: It is power loss in the field circuit and equal to $I_f^2 R_f = VI_f$. During the course of loading if field circuit resistance is not varied, field copper loss remains constant.
8. Armature copper loss: It is power loss in the armature circuit and equal to $I_a^2 R_a$. Since the value of armature current is decided by the load, armature copper loss becomes a function of time.
9. Core loss: It is the sum of eddy current and hysteresis loss and occurs mainly in the rotor iron parts of armature. With constant field current and if speed does not vary much with loading, core loss may be assumed to be constant.
10. Mechanical loss: It is the sum of bearing friction loss and the windage loss (friction loss due to armature rotation in air). For practically constant speed operation, this loss too, may be assumed to be constant.

Apart from the major losses as enumerated above there may be a small amount loss called *stray* loss occur in a machine. Stray losses are difficult to account. Power flow diagram of a d.c motor is shown in figure 40.1. A portion of the input power is consumed by the field circuit as field copper loss. The remaining power is the power which goes to the armature; a portion of which is lost as core loss in the armature core and armature copper loss. Remaining power is the gross mechanical power developed of which a portion will be lost as friction and remaining power will be the net mechanical power developed. Obviously efficiency of the motor will be given by:

$$\eta = \frac{P_{\text{net mech}}}{P_{\text{in}}}$$

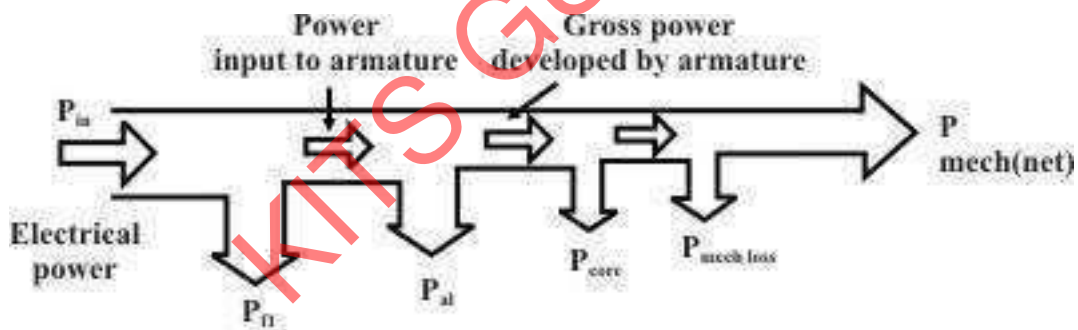

Fig. 40.1: Power flow diagram of a D.C. motor

Similar power flow diagram of a d.c generator can be drawn to show various losses and input, output power (figure 40.2).

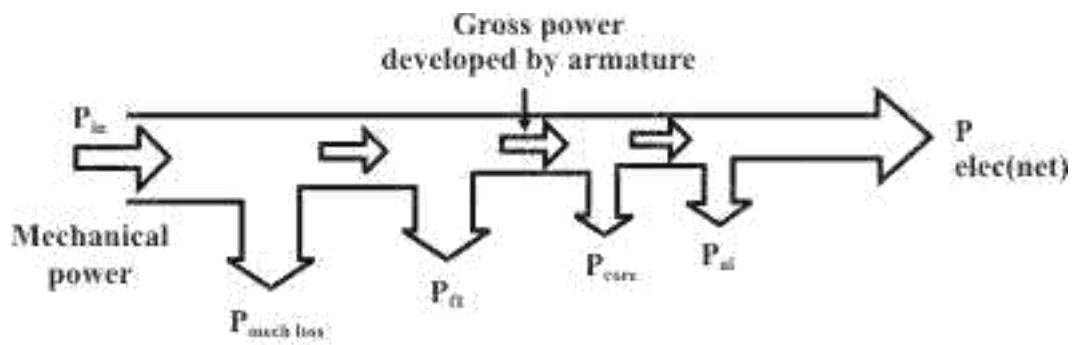

Fig. 40.2: Power flow diagram of a D.C. generator

KITS GUNTUR

It is important to note that the name plate kW (or hp) rating of a d.c machine always corresponds to the net **output** at rated condition for both generator and motor.

5.3 Swinburne's Test

For a d.c shunt motor change of speed from no load to full load is quite small. Therefore, mechanical loss can be assumed to remain same from no load to full load. Also if field current is held constant during loading, the core loss too can be assumed to remain same.

In this test, the motor is run at rated speed under *no load* condition at rated voltage. The current drawn from the supply I_{L0} and the field current I_f are recorded (figure 40.3). Now we note that:

- | | |
|---------------------------------------|-----------------------|
| Input power to the motor, P_{in} | 4. VI_{L0} |
| Cu loss in the field circuit P_{fl} | 5. VI_f |
| Power input to the armature, | 6. $VI_{L0} - VI_f$ |
| | 7. $V(I_{L0} - I_f)$ |
| | 8. VI_{a0} |
| | $= I_a^2 r_a$ |
| Cu loss in the armature circuit | $= VI_a - I_a^2 r_a$ |
| Gross power developed by armature | $= (V - I_a r_a) I_a$ |
| | 7. $b_0 a_0$ |

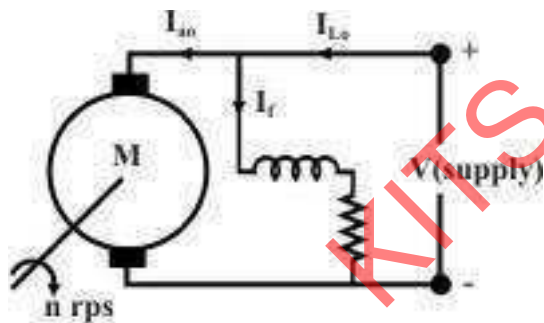

Fig. 40.3: Motor under no load

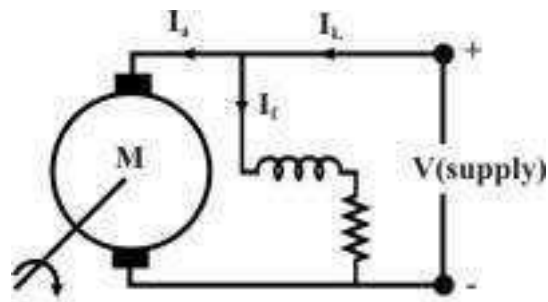

Fig. 40.4: Motor Loaded

Since the motor is operating under no load condition, net mechanical output power is zero. Hence the gross power developed by the armature must supply the core loss and friction & windage losses of the motor. Therefore,

$$P_{core} + P_{friction} = (V - I_a r_a) I_a = E_b I_a$$

Since, both P_{core} and $P_{friction}$ for a shunt motor remains practically constant from no load to full load, the sum of these losses is called constant rotational loss i.e.,

$$\text{constant rotational loss, } P_{rot} = P_{core} + P_{friction}$$

In the Swinburne's test, the constant rotational loss comprising of core and friction loss is estimated from the above equation.

After knowing the value of P_{rot} from the Swinburne's test, we can fairly estimate the efficiency of the motor at any loading condition. Let the motor be loaded such that new current drawn from the supply is I_L and the new armature current is I_a as shown in figure 40.4. To estimate the efficiency of the loaded motor we proceed as follows:

$$\begin{aligned} \text{Input power to the motor, } P_{in} &= VI_L \\ \text{Cu loss in the field circuit } P_{fl} &= VI_f \\ \text{Power input to the armature, } &= VI_L - VI_f \\ &= V(I_L - I_f) \\ &= VI_a \\ \text{Cu loss in the armature circuit} &= I_a^2 r_a \\ \text{Gross power developed by armature} &= VI_a - I_a^2 r_a \\ &= (V - I_a r_a) I_a \\ &= E_b I_a \end{aligned}$$

$$\text{Net mechanical output power, } P_{net\ mech} = E_b I_a - I_a^2 r_a$$

$$\begin{aligned} \therefore \text{efficiency of the loaded motor, } \eta &= \frac{E_b I_a - I_a^2 r_a}{VI_L} \\ &= \frac{P_{net\ mech}}{P_{in}} \end{aligned}$$

The estimated value of P_{rot} obtained from Swinburne's test can also be used to estimate the efficiency of the shunt machine operating as a generator. In figure 40.5 is shown to deliver a load current I_L to a load resistor R_L . In this case output power being known, it is easier to add the losses to estimate the input mechanical power.

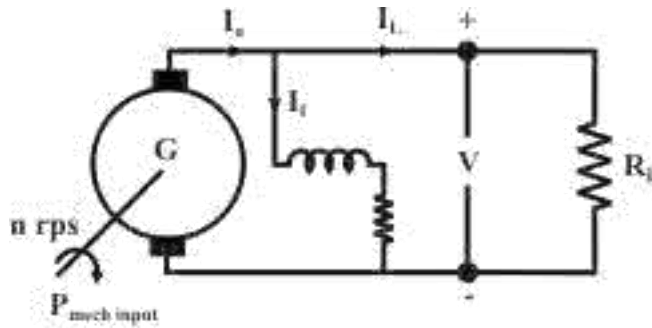

Fig. 40.5: Loaded d.c. generator

Output power of the generator, P_{out}
 Cu loss in the field circuit P_f Output
 power of the armature,

Mechanical input power, $P_{in\ mech}$

\therefore Efficiency of the generator, η

9. $V I_L$

10. $V I_f$

11. $V I_L + V I_f$

12. $V I_a + I_a^2 r + P$

13. $V I$

$\frac{a}{rot}$

(viii) $\frac{V I_L}{in\ mech}$

$\frac{V I_L}{V I_L}$

$\frac{V I_L}{V I_L + I_a^2 r + P}$

$\frac{V I_L}{V I_L + I_a^2 r + P}$

The biggest advantage of Swinburne's test is that the shunt machine is to be run as motor under *no load* condition requiring little power to be drawn from the supply; based on the no load reading, efficiency can be predicted for any load current. However, this test is not sufficient if we want to know more about its performance (effect of armature reaction, temperature rise, commutation etc.) when it is actually loaded. Obviously the solution is to load the machine by connecting mechanical load directly on the shaft for motor or by connecting loading rheostat across the terminals for generator operation. This although sounds simple but difficult to implement in the laboratory for high rating machines (say above 20 kW), Thus the laboratory must have proper supply to deliver such a large power corresponding to the rating of the machine. Secondly, one should have loads to absorb this power.

5.4 Hopkinson's test

This as an elegant method of testing d.c machines. Here it will be shown that while power drawn from the supply only corresponds to no load losses of the machines, the armature physically carries any amount of current (which can be controlled with ease). Such a scenario can be created using two similar mechanically coupled shunt machines. Electrically these two machines are eventually connected in parallel and controlled in such a way that one machine acts as a generator and the other as motor. In other words two similar machines are required to carry out this testing which is not a bad proposition for manufacturer as large numbers of similar machines are manufactured.

Procedure

Connect the two similar (same rating) coupled machines as shown in figure 40.6. With switch S opened, the first machine is run as a shunt motor at rated speed. It may be noted that the second machine is operating as a separately excited generator because its field winding is excited and it is driven by the first machine. Now the question is what will be the reading of the voltmeter connected across the opened switch S? The reading may be (i) either close to twice supply voltage or (ii) small voltage. In fact the voltmeter practically reads the difference of the induced voltages in the armature of the machines. The upper armature terminal of the generator may have either +ve or negative polarity. If it happens to be +ve, then voltmeter reading will be small otherwise it will be almost double the supply voltage.

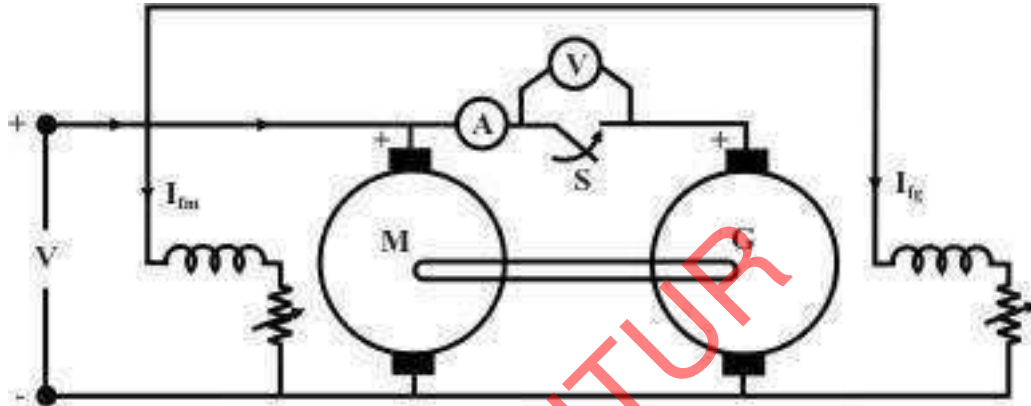

Fig. 40.6: Hopkinson's test: machines before paralleling

Since the goal is to connect the two machines in parallel, we must first ensure voltmeter reading is small. In case we find voltmeter reading is high, we should switch off the supply, reverse the armature connection of the generator and start afresh. Now voltmeter is found to read small although time is still not ripe enough to close S for paralleling the machines. Any attempt to close the switch may result into large circulating current as the armature resistances are small.

Now by adjusting the field current I_{fg} of the generator the voltmeter reading may be adjusted to zero ($E_g \approx E_b$) and S is now closed. Both the machines are now connected in parallel as shown in figure 40.7.

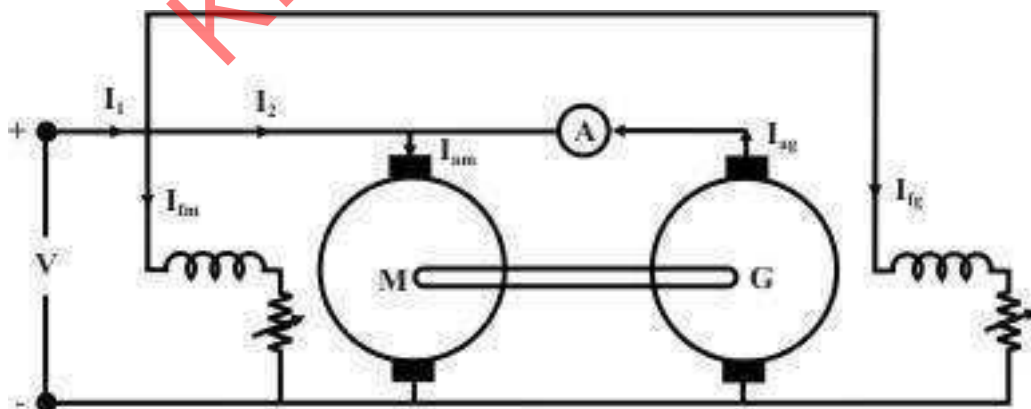

Fig. 40.7: Hopkinson's test: machines paralleled

Loading the machines

After the machines are successfully connected in parallel, we go for loading the machines i.e., increasing the armature currents. Just after paralleling the ammeter reading A will be close to zero as $E_g \approx E_b$. Now if I_{fg} is increased (by decreasing R_{fg}), then E_g becomes greater than E_b and both I_{ag} and I_{am} increase. Thus by increasing field current of generator (alternatively decreasing field current of motor) one can make $E_g > E_b$ so as to make the second machine act as generator and first machine as motor. In practice, it is also required to control the field current of the motor I_{fm} to maintain speed constant at rated value. The interesting point to be noted here is that I_{ag} and I_{am} do not reflect in the supply side line. Thus current drawn from supply remains small (corresponding to losses of both the machines). The loading is sustained by the output power of the generator running the motor and vice versa. The machines can be loaded to full load current without the need of any loading arrangement.

Calculation of efficiency

Let field currents of the machines be are so adjusted that the second machine is acting as generator with armature current I_{ag} and the first machine is acting as motor with armature current I_{am} as shown in figure 40.7. Also let us assume the current drawn from the supply be I_1 .

Total power drawn from supply is VI_1 which goes to supply all the losses (namely Cu losses in armature & field and rotational losses) of both the machines,

Now:

$$\begin{aligned}
 \text{Power drawn from supply} &= VI_1 \\
 \text{Field Cu loss for motor} &= I_{fm}^2 r_{fm} \\
 \text{Field Cu loss for generator} &= I_{fg}^2 r_{fg} \\
 \text{Armature Cu loss for motor} &= I_{am}^2 r_{am} \\
 \text{Armature Cu loss for generator} &= I_{ag}^2 r_{ag} \\
 \therefore \text{Rotational losses of both the machines} &= VI_1 - (I_{fm}^2 r_{fm} + I_{fg}^2 r_{fg} + I_{am}^2 r_{am} + I_{ag}^2 r_{ag}) \quad (40.1)
 \end{aligned}$$

Since speed of both the machines are same, it is reasonable to assume the rotational losses of both the machines are equal; which is strictly not correct as the field current of the generator will be a bit more than the field current of the motor. Thus,

$$\text{Rotational loss of each machine, } P_{rot} = \frac{VI_1 - (I_{fm}^2 r_{fm} + I_{fg}^2 r_{fg} + I_{am}^2 r_{am} + I_{ag}^2 r_{ag})}{2}$$

Once P_{rot} is estimated for each machine we can proceed to calculate the efficiency of the machines as follows,

Efficiency of the motor

As pointed out earlier, for efficiency calculation of motor, first calculate the input power and then subtract the losses to get the output mechanical power as shown below,

Total power input to the motor = power input to its field + power input to its armature

$$P_{inm} = VI_{fm} + VI_{am}$$

$$\text{Losses of the motor} = VI_{fm} + I_a^2 r_a + P_{rot}$$

$$\text{Net mechanical output power } P_{outm} = P_{inm} - (VI_{fm} + I_a^2 r_a + P_{rot})$$

$$\therefore \eta_m = \frac{P_{outm}}{P_{inm}}$$

Efficiency of the generator

For generator start with output power of the generator and then add the losses to get the input mechanical power and hence efficiency as shown below,

$$\text{Output power of the generator, } P_{outg} = VI_{ag}$$

$$\text{Losses of the generator} = VI_{fg} + I_a^2 r_a + P_{rot}$$

$$\text{Input power to the generator, } P_{ing} = \frac{P_{outg}}{\eta_g} + (VI_{fg} + I_a^2 r_a + P_{rot})$$

$$\therefore \eta_g = \frac{P_{outg}}{P_{ing}}$$

5.5 Condition for maximum efficiency

We have seen that in a transformer, maximum efficiency occurs when copper loss = core loss, where, copper loss is the variable loss and is a function of loading while the core loss is practically constant independent of degree of loading. This condition can be stated in a different way: maximum efficiency occurs when the variable loss is equal to the constant loss of the transformer.

Here we shall see that similar condition also exists for obtaining maximum efficiency in a d.c shunt machine as well.

Maximum efficiency for motor mode

Let us consider a loaded shunt motor as shown in figure 40.8. The various currents along with their directions are also shown in the figure.

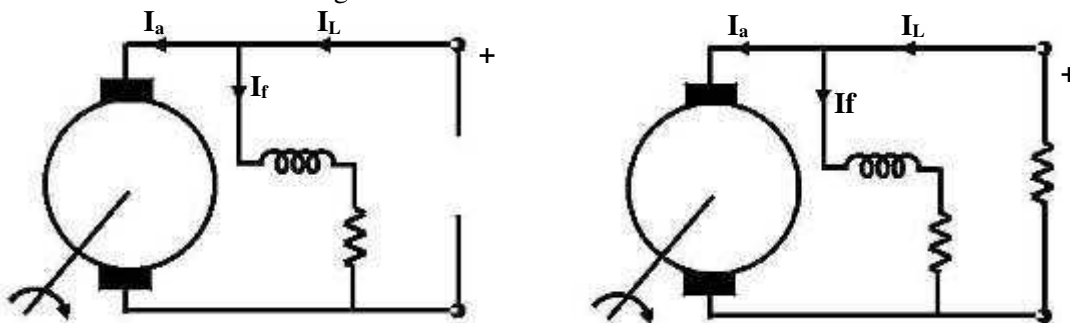

We assume that field current I_f remains constant during change of loading. Let,

P_{rot} = constant rotational loss

$V I_f$ = constant field copper loss

Constant loss $P_{const} = P_{rot} + V I_f$

Now, input power drawn from supply = $V I_L$

Power loss in the armature, = $I_a^2 r_a$

$$\begin{aligned} \text{Net mechanical output power} &= V I_L - I_a^2 r_a - (V I_f + P_{rot}) \\ &= V I_L - I_a^2 r_a - P_{const} \\ &= \frac{V I_L - I_a^2 r_a - P_{const}}{V I_L} \end{aligned}$$

so, efficiency at this load current $\eta_m = \frac{V I_L - I_a^2 r_a - P_{const}}{V I_L}$

Now the armature copper loss $I_a^2 r_a$ can be approximated to $I_L^2 r_a$ as $I_a \approx I_L$. This is because the order of field current may be 3 to 5% of the rated current. Except for very lightly loaded motor, this assumption is reasonably fair. Therefore replacing I_a by I_L in the above expression for efficiency η_m , we get,

$$\begin{aligned} \eta_m &= \frac{V I_L - I_L^2 r_a - P_{const}}{V I_L} \\ &= 1 - \frac{I_L r_a}{V} - \frac{P_{const}}{V I_L} \end{aligned}$$

V

$$\frac{d\eta_m}{dI_L} = 0$$

$$\text{or, } \frac{d}{dI_L} \left[\frac{I_L r_a}{V} - \frac{P_{const}}{V I_L} \right] = 0$$

$$\frac{dI_L}{dI_L} \frac{r_a}{V} + \frac{P_{const}}{V I_L^2}$$

$$\text{or, } -\frac{r_a}{V} + \frac{P_{const}}{V I_L^2}$$

\therefore Condition for maximum efficiency is $I_L^2 r_a \approx P_{const}$

$$\frac{d}{d I_a} \left(\frac{P_{const}}{I_a} - P_{r_a} \right)$$

So, the armature current at which efficiency becomes maximum is I_a

Thus, we get a simplified expression for motor efficiency η_m in terms of the variable current (which depends on degree of loading) I_L , current drawn from the supply. So to find out the condition for maximum efficiency, we have to differentiate η_m with respect to I_L and set it to zero as shown below.

Maximum efficiency for Generation mode

Similar derivation is given below for finding the condition for maximum efficiency in generator mode by referring to figure 40.9.

We assume that field current I_f remains constant during change of loading. Let,

KITS GUNNER

$$\frac{d\eta_g}{dI_L} = 0$$

$$\frac{d}{dI_L} \frac{VI_L}{L} = 0$$

$$\text{or, } \frac{d}{dI_L} \left(\frac{VI_L}{L} + I_a^2 r_a + P_{const} \right) = 0$$

$$\therefore \text{Simplifying we get the condition as } I_a^2 r_a \approx I_a^2 r_a = P_{const}$$

So, the armature current at which efficiency becomes maximum is $I_a = \sqrt{\frac{P_{const}}{r_a}}$

P_{rot} = constant rotational loss

$V I_f$ = constant field copper loss

Constant loss $P_{const} = P_{rot} + V I_f$

Net output power to load = $V I_L$

Power loss in the armature, = $I_a^2 r_a$

$$\begin{aligned} \text{Mechanical input power} &= V I_L + I_a^2 r_a + (V I_f + P_{rot}) \\ &= V I_L + I_a^2 r_a + P_{const} \end{aligned}$$

$$\text{so, efficiency at this load current } \eta_g = \frac{V I_L}{V I_L + I_a^2 r_a + P_{const}}$$

As we did in case of motor, the armature copper loss $I_a^2 r_a$ can be approximated to $I_L^2 r_a$ as

$I_a \approx I_L$. So expression for η_g becomes,

$$\eta_g = \frac{V I_L}{V I_L + I_L^2 r_a + P_{const}}$$

Thus, we get a simplified expression for motor efficiency η_g in terms of the variable current (which depends on degree of loading) I_L , current delivered to the load. So to find out the condition for maximum efficiency, we have to differentiate η_g with respect to I_L and set it to zero as shown below.

Thus maximum efficiency both for motoring and generating are same in case of shunt machines. To state we can say at that armature current maximum efficiency will occur which will make variable loss = constant loss. Eventually this leads to the expression for armature current for maximum efficiency as $I_a = \sqrt{\frac{P_{const}}{r_a}}$.